

# robosense® LiDAR

## RS-Ruby Plus

User Manual

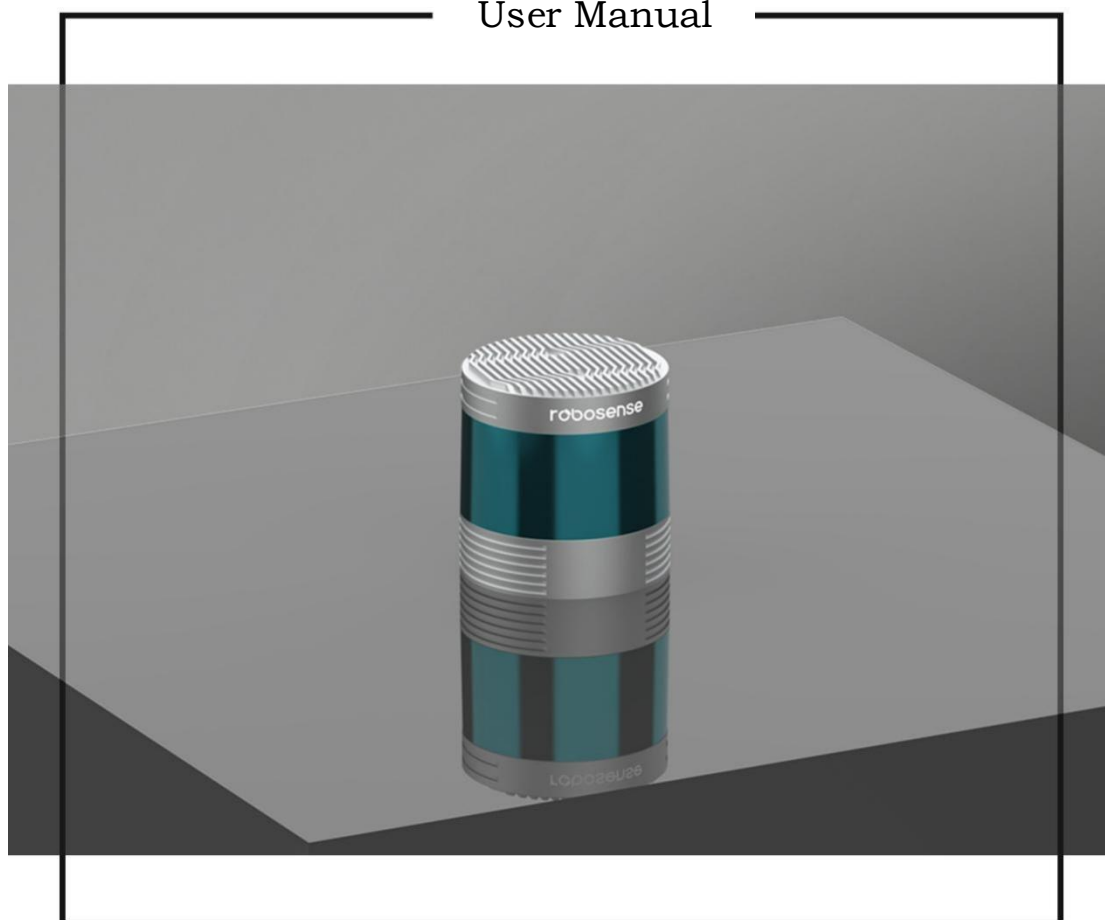

| Issue | Modifications   | Release Date | Edited by |
|-------|---|--------------|-----------|
| 1.0.0 | Original issue  | 2022-04-08   | PD        |
| 1.0.1 | <ol style="list-style-type: none"><li>1.Updated performance parameters;</li><li>2.Added Appendix F correspondence table of channel ranging ability</li><li>3.Corrected the calculation formula for Current, Voltage and Temperature</li><li>4.Added the introduction of high performance mode</li><li>5.Added description of motor rotation direction</li></ol> | 2022-6-29    | PD        |
| 1.0.2 | <ol style="list-style-type: none"><li>1.Corrected current calculation formula</li><li>2.Added description of accessories</li></ol>  | 2022-7-4     | PD        |
| 1.0.3 | <ol style="list-style-type: none"><li>1. Modify the calculation formula of voltage and temperature</li><li>2. Modify the frame header structure of the MSOP packet</li></ol>  | 2022-7-7     | PD        |
| 1.0.4 | <ol style="list-style-type: none"><li>1.Correct the MSOP description</li><li>2.Correct the picture of rotation direction</li></ol>  | 2022-9-9     | PD        |

## Terminologies

|           |  |
|-----------|--|
| MSOP      | Main data Stream Output Protocol   |
| DIFOP     | Device Info Output Protocol  |
| FOV       | Field Of View  |
| PTP       | Precision Time Protocol  |
| NTP       | Network Time Protocol  |
| GPS       | Global Positioning System  |
| UTC       | Universal Time Coordinated   |
| Protocol  | Protocol version number, 01 represents old version, 02 represents the latest version |
| Wave_mode | Echo flag  |
| Temp      | Sensor temperature information   |
| Resv      | Reserved data flag   |
| Ret_id    | Return ID in the data packet   |
| Azimuth   | LiDAR horizontal rotation angle  |
| Timestamp | Time stamp which is used to record system time                                       |
| Header    | Frame header in protocol packet  |
| Tail      | Frame tail in protocol packet  |

# Content

|  |    |
|--|----|
| 1 Safety Notices .....   | 1  |
| 2 Product Appearance and Interface .....                       | 2  |
| 2.1 Product Appearance .....                                   | 2  |
| 2.2 Aviation Plug and Pin Definition .....                     | 2  |
| 2.2.1 Power .....  | 4  |
| 2.2.2 RJ45 Ethernet Port .....                                 | 5  |
| 2.2.3 I/O definition .....                                     | 5  |
| 3 Unboxing & Installation .....                                | 6  |
| 3.1 Optional accessories .....                                 | 6  |
| 3.2 Sensor Mounting .....                                      | 6  |
| 3.3 Quick Connection .....                                     | 7  |
| 4 Sensor Specifications and Features .....                     | 8  |
| 4.1 Sensor Specification <sup>1</sup> .....                    | 8  |
| 4.1.1 Parameters .....   | 8  |
| 4.2 Point Cloud Display .....                                  | 9  |
| 4.2.1 Coordinate Mapping .....                                 | 9  |
| 4.3 Reflectivity .....   | 9  |
| 4.4 Laser Return Modes .....                                   | 10 |
| 4.4.1 Principle of Laser Return Modes .....                    | 10 |
| 4.4.2 Return Mode Flag .....                                   | 11 |
| 4.5 Phase Locking .....  | 11 |
| 4.6 Time Synchronization .....                                 | 12 |
| 4.6.1 GPS Time Synchronization .....                           | 12 |
| 4.6.2 The Use of GPS for Time Synchronization .....            | 12 |
| 4.6.3 PTP Time Synchronization .....                           | 13 |
| 4.6.4 PTP wiring Method .....                                  | 13 |
| 4.6.5 Time Calculation .....                                   | 14 |
| 5 Communication Protocol .....                                 | 16 |
| 5.1 MSOP and DIFOP .....                                       | 16 |
| 5.2 Main Data Stream Output Protocol (MSOP) .....              | 17 |
| 5.2.1 Header .....   | 17 |
| 5.2.2 Data Blocks .....  | 18 |
| 5.2.3 Tail .....   | 20 |
| 5.3 Device Info Output Protocol (DIFOP) .....                  | 20 |
| 6 Vertical Angles and Precision Point Timing Calculation ..... | 22 |
| 6.1 Channel Number and Vertical Angle .....                    | 22 |
| 6.2 Exact Point Timing Calculation .....                       | 22 |
| 7 Troubleshooting .....  | 26 |
| Appendix A Web Interface .....                                 | 28 |
| A.1 Device Screen .....  | 28 |
| A.2 Web Interface for Sensor Setting .....                     | 28 |
| A.3 Diagnostic Screen .....                                    | 31 |

|  |    |
|--|----|
| A.4 System Screen .....  | 32 |
| Appendix B Information Registers .....                           | 34 |
| B.1 Motor Speed (MOT_SPD) .....                                  | 34 |
| B.2 Ethernet (ETH) .....   | 34 |
| B.3 FOV Setting (FOV_SET) .....                                  | 35 |
| B.4 Motor Phase Offset (MOT_PHASE) .....                         | 35 |
| B.5 Top Board Firmware Version (TOP_FRM) .....                   | 35 |
| B.6 Bottom Board Firmware Version(BOT_FRM) .....                 | 36 |
| B.7 Software Version(SOF_FRM) .....                              | 36 |
| B.8 Web CGI Version(SOF_FRM) .....                               | 36 |
| B.9 Corrected Vertical Angle(COR_VERT_ANG) .....                 | 36 |
| B.10 Corrected Horizontal Angle(COR_HOR_ANG) .....               | 37 |
| B.11 Serial Number(SN) .....                                     | 38 |
| B.12 Time synchronization Setting (Sync_set) .....               | 38 |
| B.13 Time synchronization Status (Sync_Status) .....             | 39 |
| B.14 UTC Time (UTC_TIME) .....                                   | 39 |
| B.15 Rotation Direction (ROTATION) .....                         | 39 |
| B.16 STATUS (STATUS) .....                                       | 39 |
| B.17 Fault Diagnosis (FALT_DIGS) .....                           | 40 |
| B.18 GPRMC Data Packet-ASCII Code Data Type .....                | 41 |
| Appendix C RSView .....  | 42 |
| C.1 Software Features .....                                      | 42 |
| C.2 Install RSView .....   | 42 |
| C.3 Set Up Network .....   | 42 |
| C.4 Visualize Streaming Sensor Data .....                        | 43 |
| C.5 Capture Streaming Sensor Data to PCAP File .....             | 44 |
| C.6 Replay PCAP File .....                                       | 45 |
| Appendix D RS-Ruby Plus ROS&ROS2 Package .....                   | 48 |
| D.1 Install Software .....                                       | 48 |
| D.2 Download & Compile RoboSense LiDAR Driver Package .....      | 48 |
| D.3 Configure PC IP .....  | 49 |
| D.4 Real Time Display .....                                      | 49 |
| D.5 View Offline Data .....                                      | 50 |
| Appendix E Mechanical Drawings .....                             | 51 |
| Appendix F Correspondence Table of Channel Ranging Ability ..... | 52 |
| Appendix G Sensor Cleaning .....                                 | 52 |
| G.1 Attention .....  | 53 |
| G.2 Cleaning Method .....  | 53 |
| G.3 Required Materials .....                                     | 53 |

## 1 Manufacturer Information

Suteng Innovation Technology Co., Ltd. (RoboSense)

Building 9, Block 2, Zhongguan Honghualing Industry Southern District, 1213 Liuxian Avenue,  
Taoyuan Street, Nanshan District, Shenzhen, China Landline: 0755-86325830

Mobile Phone: +86 15338772453(Marketing & Sales Cooperation)

Email: service@robosense.cn

Working hours from Monday to Friday 09:00-18:00(GMT/UTC +8)

## 2 Disclaimer of Liability

This manual is protected by copyright. Any rights arising from this copyright are owned by RoboSense. Reproduction of this manual or part of the manual is only permitted within the legal scope of the copyright law. Without obtaining any authorization, this document shall not be abridged or translated. The trademarks mentioned in this document are the property of their respective owners. RoboSense reserves all rights.

## 3 Certifications

Coming soon

Note:

This manual is updated from time to time without prior notice, to get the latest version, please visit RoboSense company website to download or contact the RoboSense Technical Support or Sales.

## 1 Safety Notices

To avoid risks of accidents, damage to sensor or violating of your product warranty, please read and follow the instructions in this manual carefully before operating the product.

- Please pay attention to the overheating sign on the LiDAR surface to avoid a hot LiDAR surface that may lead to sensor failure or undesirable consequences.



- Retain Instructions - The safety and operating instructions should be retained for future reference.
- Heed Warnings - All warnings on the product and in the operating instructions should be adhered to.
- Servicing – Except for what's described in this manual, the sensor has no field serviceable parts. For servicing, please contact RoboSense sales or the authorized distributors.

## 2 Product Appearance and Interface

### 2.1 Product Appearance

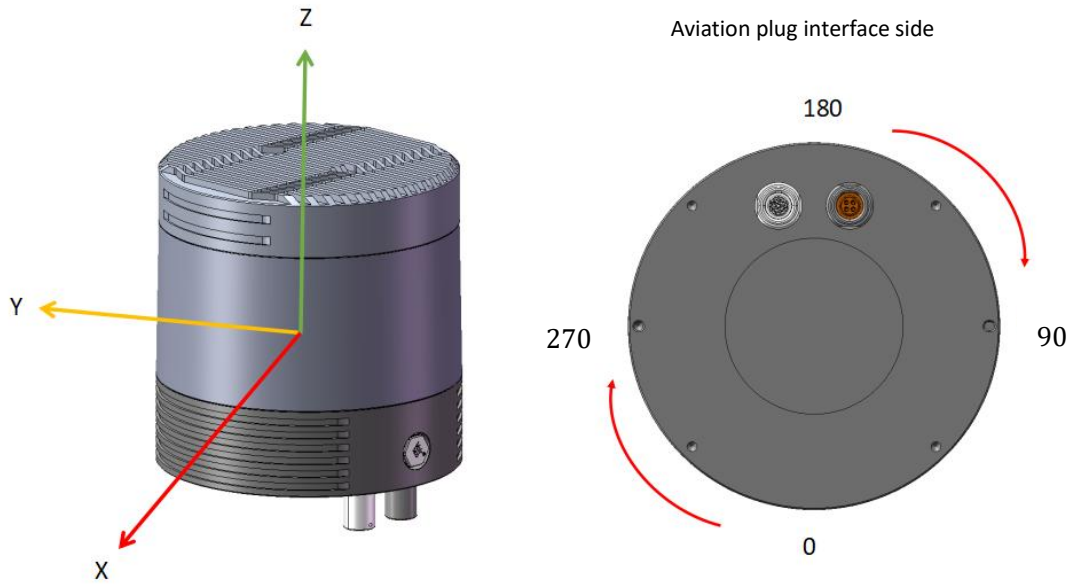

Figure 2-1 LiDAR Coordinate and Rotation Direction

### 2.2 Aviation Plug and Pin Definition

RS-Ruby Plus has two aviation plugs attached to the bottom of the LiDAR, the definitions of the specific pins of the aviation plug are as shown in the table below:

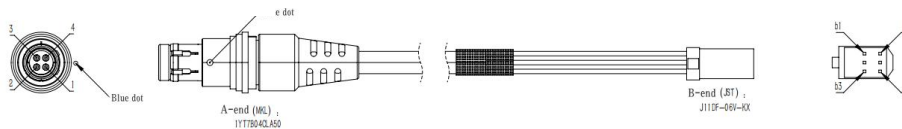

Figure 2-2 4 pin Airline

Table 2-1 4 Definition of pin Airline

| Pin A | Color  | Definition | Pin B |
|-------|--------|------------|-------|
| 1     | Red    | TRD_P      | a1    |
| 2     | Black  | TRD_N      | b1    |
| 3     | White  | PGND       | a2    |
| 4     | Green  | PGND       | b2    |
| Shell | Shield | PGND       | a3    |
|       |        |            | b3    |



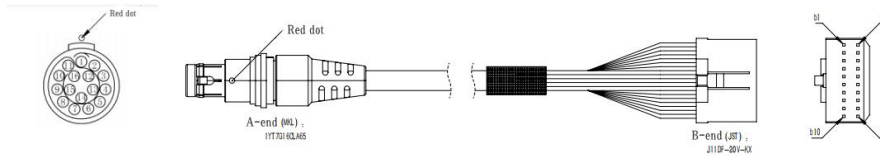

Figure 2-3 16 Pin Airline

Table 2-2 16 Definition of pin Airline

| Pin A | Color            | Definition | Pin B |
|-------|------------------|------------|-------|
| 1     | Blue             | Power      | a1    |
| 2     | Blue and White   | Power      | b1    |
| 3     | Pink             | Power      | a2    |
| 4     | Grey             | Power      | b2    |
| 5     | Red              | GND        | a3    |
| 6     | Red and White    | GND        | b3    |
| 7     | Black            | GND        | a4    |
| 8     | Black and White  | GND        | b4    |
| 9     | Green            | /          | a5    |
| 10    | Green and White  | /          | b5    |
| 11    | Purple           | PPS        | a6    |
| 12    | Purple and White | GPRMC      | b6    |
| 13    | Orange           | SYNC_OUT1  | a7    |
| 14    | Orange and White | SYNC_OUT2  | b7    |
| 15    | Brown            | SYNC_OUT3  | a8    |
| 16    | Brown and White  | PGND       | b8    |
| Shell | Shield           | /          | a9    |
|       |                  | /          | b9    |
| /     | /                | /          | a10   |
| /     | /                | /          | b10   |

RS-Ruby Plus comes with an Interface Box, which has LED lights and provides convenient connections to power, RJ45 Ethernet, and GPS. (The length of the integrated cable attached to the Interface Box of the aviation plug version LiDAR is 3 meters, for other cable lengths, please contact RoboSense technical support).

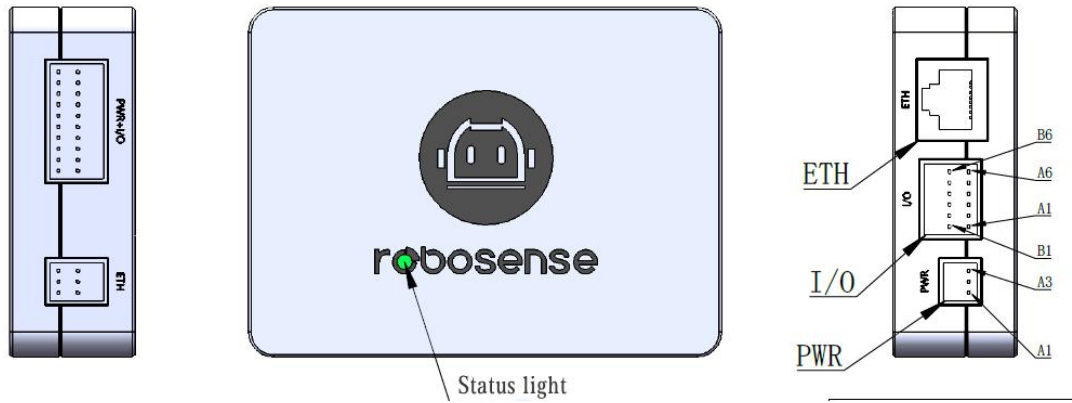

Figure 2-4 Interface Box Schematic

Table 2-3 Definition of PWR

| No. | Color | Definition |
|-----|-------|------------|
| A1  | Black | GND        |
| A2  | Black | GND        |
| A3  | Blue  | Power      |

Table 2-4 Definition of I/O

| No. | Color            | Definition |
|-----|------------------|------------|
| A1  | Blue             | +5V        |
| B1  | Orange           | SYNC_OUT_1 |
| A2  | Purple           | GPS_PPS    |
| B2  | Orange and White | SYNC_OUT_2 |
| A3  | Purple and White | GPRMC      |
| B3  | Brown            | SYNC_OUT_3 |
| A4  | Red              | GND        |
| B4  | /                | /          |
| A5  | Red and White    | GND        |
| B5  | /                | /          |
| A6  | Black and White  | GND        |
| B6  | /                | /          |

Specifications of Interface Box ports:

Table 2-5 Interface Box Port Specification

| No. | Port        | Specification (Outlet)  | Specification (Connect the radar) |
|-----|-------------|-------------------------|-----------------------------------|
| 1   | Power Input | JST S03B-J11SK-TXR      | JST S20B-J11DK-TXR                |
| 2   | I/O         | JST S12B-J11DK-TXR      |                                   |
| 3   | Network     | Standard RJ45 connector | JST S06B-J11Dk-TXR                |

### 2.2.1 Power

The RS-Ruby Plus power supply interface on the Interface Box is a JST S03B-J11SK-TXR Model connector, and comes with a standard DC 5.5-2.1 connector. When the power input is normal,

the green LED lights up, please check if the power input is normal when the green LED lights off. If the power input is normal, the Interface BOX may be damaged. Please contact our technical support & sales.

### 2.2.2 RJ45 Ethernet Port

The RS-Ruby Plus only supports the T1 car Ethernet. The network interface on the Interface Box follows the RJ45 standard.

### 2.2.3 I/O definition

The definition of the RS-Ruby Plus interface box and the corresponding position of each interface are shown in table 2-3 and table 2-4: SYNC\_OUT\_1, SYNC\_OUT\_2, SYNC\_OUT\_3 are angle trigger pin, which can trigger camera to take pictures; PPS+GPRMC uses GPS for Time Synchronization;The + 5V is used for GPS power supply.

Note: When the "ground" of RS-Ruby Plus is connected to an external system, the negative polarity ("ground") of the external system and the "ground" of the GPS system must share a non-isolated common ground.

### 3 Unboxing & Installation

#### 3.1 Optional accessories

RS-Ruby Plus package does not include accessories by default and requires additional purchase; The table below lists the optional accessories of RS-Ruby Plus from the factory.

Table 3-1 Optional Accessories of the RS-Ruby Plus

| No. | Contents       | SPEC/QTY           |
|-----|----------------|--------------------|
| 1   | Interface Box  | *1                 |
| 2   | 4 pin Airline  | 3m /4m/6m/12m      |
| 3   | 16 pin Airline | 3m /4m/6m/12m      |
| 4   | Power Adapter  | DC12Vx3.34A/40W *1 |
| 5   | Power Cable    | 1.2M *1            |
| 6   | Ethernet Cable | 1.5M *1            |
| 7   | Screw Pack     | M4x10 *3           |

Note: If there are special requirements, please refer to the actual negotiation.

#### 3.2 Sensor Mounting

As shown in the figure below, the mounting surface of the LiDAR should be flat and uneven surfaces should be avoided. The precise locator pins on the mounting base should strictly follow the dimensions of the locator holes at the bottom of the LiDAR, and the height of the locator pin should not be higher than 4mm. We recommend using aluminum alloy for the mounting base material, which facilitates heat dissipating of the LiDAR during operating.

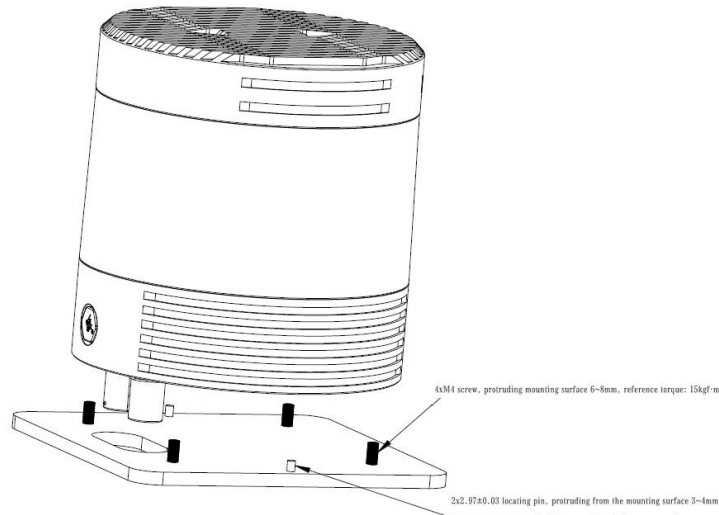

Figure 3-1 LiDAR Mounting Details

The following situations should be **avoided** when mounting the LiDAR:

- 1) If there are contact mounting surfaces on the top and bottom of the LiDAR, please ensure that the distance between the mounting surfaces is greater than the height of the LiDAR to avoid squeezing the LiDAR.
- 2) The installation inclination angle should be more than 15 degrees
- 3) When connecting cables of the LiDAR, make sure not to pull the cable too tightly, and keep the cables in a slack state.

### 3.3 Quick Connection

Users are allowed to configure the network settings of the RS-Ruby Plus, which is set at the factory with default IP and port numbers, as shown in the table below:

Table 3-2 Factory Default Network Configuration

|              | IP Address    | MSOP Port No. | DIFOP Port No. |
|--------------|---------------|---------------|----------------|
| RS-Ruby Plus | 192.168.1.200 | 6699          | 7788           |
| Computer     | 192.168.1.102 |               |                |

To establish communication between the LiDAR and computer, it's required to set the computer's IP address to the same network segment as the LiDAR, for example 192.168.1.x (the value of x could be from 1 to 254), and the subnet mask to 255.255.255.0. If you don't know the network configuration of the LiDAR, please connect the LiDAR to computer and use wireshark to capture the LiDAR data packets to analyze.

## 4 Sensor Specifications and Features

### 4.1 Sensor Specification<sup>1</sup>

#### 4.1.1 Parameters

Table 4-1 Sensor Parameters

| Sensor                               |  |  |   |
|--------------------------------------|--|--|---|
| Laser Channels                       | 128  | FOV(Horizontal)                            | 360°  |
| Laser Wavelength                     | 905nm  | FOV(Vertical)                              | + 15° ~ -25° (40°in total)                                      |
| Laser Emission Angle<br>(Full Angel) | Horizontal:2.0mrad<br>Vertical: 1.7mrad  | Angular Resolution<br>(Horizontal)         | 0.2°/ 0.4° (Balance Mode)<br>0.1°/ 0.2° (High Performance Mode) |
| Laser Safety                         | Class 1 Eye-safe   | Angular Resolution<br>(Vertical)           | +3.82°~-6.51°: 0.1° (104 channels)                              |
| Measurement Range <sup>1</sup>       | 0.4m to 240m<br>(240m@10% NIST)  | Ranging Accuracy<br>(Typical) <sup>2</sup> | Up to±3cm   |
| Blind Distance                       | ≤0.4m  | Frame Rate                                 | 10Hz/ 20 Hz   |
| Rotation Speed                       | 600/ 1200 rmp(10/20Hz)   |  |   |
| Output                               |  |  |   |
| Data Rate                            | 2,304,000pts/s (Single Return Mode) 4,608,000pts/s (Dual Return Mode)<br>4,608,000pts/s (High Performance Mode) 9,216,000pts/s (High Performance Mode) |  |   |
| Ethernet                             | 1000M-Base-T1  |  |   |
| Data Output Protocol                 | UDP packets over Ethernet  |  |   |
| UDP Packets Content                  | 3D Coordinates, Calibrated Reflectivity Measurements, Time Stamps  |  |   |
| Mechanical                           |  |  |   |
| Operating Voltage                    | 9V - 32V   | Dimension                                  | φ125mm * H128 mm  |
| Power Consumption <sup>3</sup>       | 27W (Typical)  | Operating Temperature <sup>4</sup>         | -40°C ~ +60°C   |
| Weight                               | 1.85kg (LiDAR body)  | Storage Temperature                        | -40°C ~ +85°C   |
| Time Synchronization                 | SGPRMC with 1 PPS & PTP/gPTP   | Sensor Protection                          | IP67/IP6K9K   |

<sup>1</sup> The measurement range is based on a 10% NIST diffuse reflector, and the test results may be affected by the environment conditions, including but not limited to ambient temperature, light intensity and other factors;

<sup>2</sup> The ranging accuracy takes a 50% NIST diffuse reflector as the target. The test results may be affected by environment conditions, including but not limited to factors such as ambient temperature and target distance. The accuracy value is applicable to most channels, and there may exists differences between some channels.

<sup>3</sup> The power consumption of the device may be affected by environment conditions, including but not limited to factors such as ambient temperature, target distance, target reflectivity, etc.

<sup>4</sup> The operating temperature of the device may be affected by environment conditions, including but not limited to factors such as ambient light and airflow changes.

## 4.2 Point Cloud Display

### 4.2.1 Coordinate Mapping

Since the data packet output by the LiDAR only provides the horizontal rotation angle and distance parameters, in order to present a 3D point cloud image, the angle and distance information in polar coordinates need to be converted into x, y, z coordinates in the Cartesian coordinate system, and the conversion formula is as follows:

$$\begin{cases} x = r \cos(\omega) \sin(\alpha); \\ y = r \cos(\omega) \cos(\alpha); \\ z = r \sin(\omega); \end{cases}$$

Where  $r$  is the measured distance,  $\omega$  is the vertical angle of the laser,  $\alpha$  is the horizontal rotation angle of the laser in the Polar Coordinate System, and x, y, z are the coordinate values in the Cartesian Coordinate System

Note : SDK source code of RS-Ruby Plus has by default completed the coordinate conversion to conform to the right-handed coordinate system of ROS. The X-axis of ROS is the positive Y direction in Figure 2-1, and the Y-axis of ROS is the negative X direction in Figure 2-1.

---

## 4.3 Reflectivity

RS-Ruby Plus measures the reflectivity of objects. The reflectivity is an index that measures the ability of an object to reflect light and is greatly related to the material of the object itself. Therefore, the reflectivity information can be used to distinguish objects of different materials.

RS-Ruby Plus reports calibrated reflectivity values from 0 to 255, among which diffuse reflectors report values from 0 to 100, and retroreflectors report values from 101 to 255. Black objects are with low reflectivity values, white objects are with high reflectivity values, the most ideal reflection reports the reflectivity value of 255.

## Diffuse Reflectors

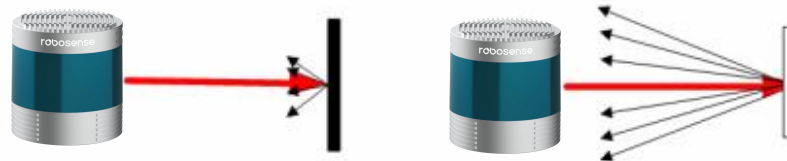

Black, absorbent diffuse reflector  
Reflectivity  $\approx 0$

White, reflective diffuse reflector  
Reflectivity  $< 100$

## Retro-Reflectors



Retro-reflector covered with-  
Semi transparent white surface  
Reflectivity  $> 100$

Retro-reflector without any coverage  
Reflectivity  $\approx 255$

Figure 4-1 Definition of Reflectivity

## 4.4 Laser Return Modes

### 4.4.1 Principle of Laser Return Modes

RS-Ruby Plus supports multiple laser return modes, namely: Strongest, Last, First, and Dual. When set to Dual Return mode, the details of the target will increase, and the volume of data is twice that in the Single Return mode.

Due to beam divergence, multiple laser returns are possible from any single laser shot. After a laser pulse is shot, the beam size becomes larger and larger as it travels in the air, when a beam is large enough to hit multiple objects, it will produce multiple reflections.

RS-Ruby Plus analyzes the received multiple returns, and can be set to only report the strongest return, first return or the last return each time in the single return mode, or report the strongest and last return, the strongest and first return, or the first and the last return at the same time in dual return mode, depending on the laser return mode settings. If it is set to the strongest return mode, only the value of strongest return will be reported. Similarly, if it is set to the last return mode, only the value of the last return will be reported.



Note:

- 1) The sensor records both returns only when the distance between two objects is 2meter or more.
- 2) When a laser pulse hits only one object, there is only the strongest return.

#### 4.4.2 Return Mode Flag

The RS-Ruby Plus is set in the Strongest Return mode at factory by default. If you need to change this settings, please refer to Appendix A of this user manual for instructions. The 300th byte in a DIFOP packet is the flag of return mode, which corresponds to the following:

Table 4-2 Return Mode Flag

| Flag | Return Mode              |
|------|--------------------------|
| 00   | Strongest Return         |
| 01   | Last Return              |
| 02   | First return             |
| 03   | Strongest + Last Return  |
| 04   | Strongest + First Return |
| 05   | Last + First return      |

#### 4.5 Phase Locking

The phase locking feature, when a PPS pulse signal is triggered, asks the RS-Ruby Plus to rotate to a specific angle to fire laser pulses. When multiple RS-Ruby Plus sensors are used at the same time, the relative rotation angle between them is kept unchanged. The normal phase locking requires the normal and stable PPS pulse triggering signal.

Figure 4-2 shows the RS-Ruby Plus set with different phases. The red arrows indicate the firing angle of the sensor’s laser at the moment it receives the rising edge of the PPS signal. In the cases below: 0 degrees, 135 degrees, and 270 degrees respectively.

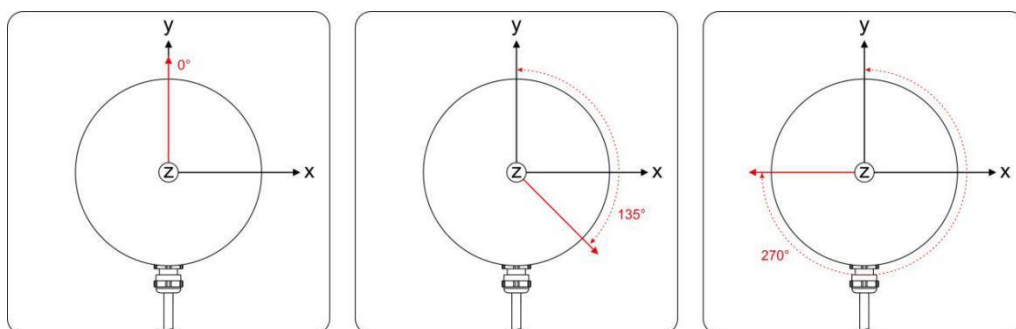

Figure 4-2 RS-Ruby Plus Different Phase Settings

Using the Web Interface, click **Setting > Phase Lock Setting**, for the "Phase Lock" parameter setting. The phase locking value can be set from 0 to 359.

### 4.6 Time Synchronization

RS-Ruby Plus supports GPS+PPS and PTP time synchronization methods. Users can use the RS-Ruby Plus Web Interface to set. (Please refer to Appendix A.2)

RS-Ruby Plus can be connected to an external GPS module and can synchronize the sensor system time with the time provided by the GPS.

#### 4.6.1 GPS Time Synchronization

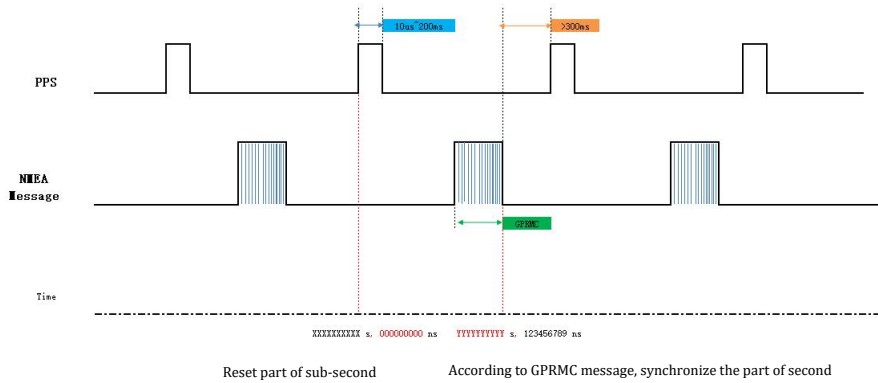

Figure 4-3 GPS Time Synchronization Timing Diagram

The GPS module continuously sends GPRMC message and PPS synchronization pulse signals to the sensor. The PPS synchronization pulse width is from 20ms to 200ms, and the GPRMC message must be sent within 500ms after the rising edge of the PPS synchronization pulse.

#### 4.6.2 The Use of GPS for Time Synchronization

The GPS\_REC interface in the Interface Box of the RS-Ruby Plus follows the RS232 level standard, as shown in the table below:

Table 4-3 GPS Receive Pin Definition

| Level | Receive Pin Definition                                 |  |
|-------|--|--|
|       | GPS GPRMC  | GPS PPS  |
| RS232 | Receive the RS232 serial data output by the GPS module | Receive the positive synchronization pulse signal output by the GPS module, the level is required to be 3.0V~15.0V |

Note 1: The GPS\_REC interface in the RS-Ruby Plus Interface Box is the JST S12B-J11DK-TXR connector, and the pin definition is as shown in Figure 2-4.

The external GPS module needs to set the serial output baud rate to 9600bps, 8 bits, no parity, 1 stop bit. RS-Ruby Plus only accepts the GPRMC sentence sent by the GPS module. The standard structure of the GPRMC sentence is as follows:

\$GPRMC,<1>,<2>,<3>,<4>,<5>,<6>,<7>,<8>,<9>,<10>,<11>,<12>\*hh

- <1> UTC Time
- <2> Receiver status, A=active, V=void
- <3> Latitude
- <4> Latitudinal hemisphere N (northern hemisphere) or S (southern hemisphere)
- <5> Longitude
- <6> Longitudinal hemisphere E (east longitude) or W (west longitude)
- <7> Speed over the ground(knots)
- <8> Track made good (degrees True)
- <9> UTC date
- <10> Magnetic declination
- <11> Magnetic declination direction, E (east) or W (west)
- <12> Mode indicator (A=autonomous, D=differential, E=estimated, N=not valid)

\* The last hh is the XOR sum of all characters from \$ to \*

The length of GPRMC messages sent by existing GPS modules on the market is not consistent. The length of GPRMC messages reserved in the DIFOP packet of RS-Ruby Plus is up to 86 bytes, which is compatible with the GPRMC message format sent by most GPS modules on the market. If an incompatibility occurs, please contact RoboSense technical support.

#### 4.6.3 PTP Time Synchronization

PTP (Precision Time Protocol) is a time synchronization protocol, which itself is only used for high-precision time synchronization between devices, but it can also be borrowed for frequency synchronization between devices. Compared with various existing time synchronization mechanisms, PTP has the following advantages:

- 1) Compared with NTP (Network Time Protocol, Network Time Protocol), PTP can meet higher-precision time synchronization requirements. NTP can generally only achieve sub-second time synchronization accuracy, while PTP can reach sub-microsecond time synchronization accuracy.
- 2) Compared with GPS (Global Positioning System), PTP has lower construction and maintenance costs. And it is also of special significance in national security because it can get rid of the dependence on GPS.

#### 4.6.4 PTP wiring Method

To use the PTP synchronization method, you need to make the following preparations, and then connect according to the connection method shown in the figure below:

- 1) Select PTP mode in the web interface (please see Appendix A.2 Web Interface configuration);
- 2) Prepare a PTP Master timing host (plug and play, no additional configuration required);
- 3) Ethernet switch;
- 4) Device supporting PTP protocol

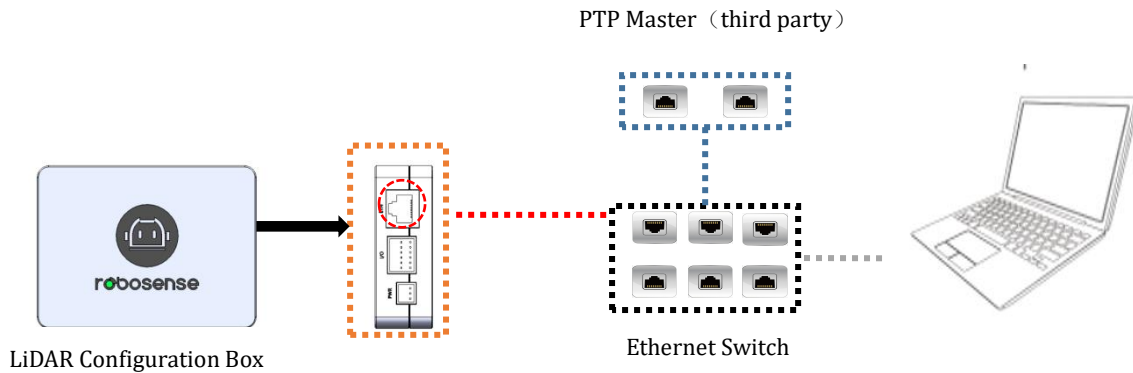

Figure 4-4 PTP Connecting Diagram

Note:

1. The PTP Master timing equipment is a third-party equipment that needs to be purchased by the user independently, which is not included in the shipping package.
2. As a PTP Slave device, our LiDAR only obtains the time sent by the PTP Master, and does not make accuracy judgments. If the time of the LiDAR deviates from the real time, please check whether the time provided by the PTP Master is accurate;
3. After the LiDAR is synchronized, the PTP Master is disconnected, and the time in the point cloud data packet will be superimposed according to the LiDAR's internal clock, and it will be reset after the LiDAR is powered off and restarted.

#### 4.6.5 Time Calculation

MSOP packets contain time information, a set of default times is used for timing without external time synchronization and it will be updated after using the external time synchronization。

The timestamp analysis in the point cloud data package is as follows:

| No. | Time      | Source        | Destination   | Protocol | Length | Info                 |
|-----|-----------|---------------|---------------|----------|--------|----------------------|
| 1   | 0.000000  | 192.168.1.200 | 192.168.1.102 | UDP      | 1290   | 6699 → 6699 Len=1248 |
| 2   | 0.000020  | 192.168.1.200 | 192.168.1.102 | UDP      | 1290   | 6699 → 6699 Len=1248 |
| 3   | 0.000042  | 192.168.1.200 | 192.168.1.102 | UDP      | 1290   | 6699 → 6699 Len=1248 |
| 4   | 0.000062  | 192.168.1.200 | 192.168.1.102 | UDP      | 1290   | 6699 → 6699 Len=1248 |
| 5   | 0.000083  | 192.168.1.200 | 192.168.1.102 | UDP      | 1290   | 6699 → 6699 Len=1248 |
| 6   | 0.000103  | 192.168.1.200 | 192.168.1.102 | UDP      | 1290   | 6699 → 6699 Len=1248 |
| 7   | 0.000122  | 192.168.1.200 | 192.168.1.102 | UDP      | 1290   | 6699 → 6699 Len=1248 |
| 8   | 0.0001902 | 192.168.1.200 | 192.168.1.102 | UDP      | 1290   | 6699 → 6699 Len=1248 |
| 9   | 0.001927  | 192.168.1.200 | 192.168.1.102 | UDP      | 1290   | 6699 → 6699 Len=1248 |
| 10  | 0.001947  | 192.168.1.200 | 192.168.1.102 | UDP      | 1290   | 6699 → 6699 Len=1248 |
| 11  | 0.001967  | 192.168.1.200 | 192.168.1.102 | UDP      | 1290   | 6699 → 6699 Len=1248 |
| 12  | 0.001987  | 192.168.1.200 | 192.168.1.102 | UDP      | 1290   | 6699 → 6699 Len=1248 |
| 13  | 0.002009  | 192.168.1.200 | 192.168.1.102 | UDP      | 1290   | 6699 → 6699 Len=1248 |
| 14  | 0.002027  | 192.168.1.200 | 192.168.1.102 | UDP      | 1290   | 6699 → 6699 Len=1248 |
| 15  | 0.002049  | 192.168.1.200 | 192.168.1.102 | UDP      | 1290   | 6699 → 6699 Len=1248 |
| 16  | 0.002069  | 192.168.1.200 | 192.168.1.102 | UDP      | 1290   | 6699 → 6699 Len=1248 |
| 17  | 0.002089  | 192.168.1.200 | 192.168.1.102 | UDP      | 1290   | 6699 → 6699 Len=1248 |
| 18  | 0.002111  | 192.168.1.200 | 192.168.1.102 | UDP      | 1290   | 6699 → 6699 Len=1248 |

| Example: 1290 bytes captured on wire (10320 bits) 1290 bytes captured (10320 bits) |   |
|--|---|
| 0000   | 6c 02 e0 7a ae 40 40 2c 76 86 26 88 08 00 45 00 |
| 0010   | 04 fc 16 5f 40 00 40 11 9b 13 c0 a8 01 c8 c0 a8 |
| 0020   | 01 66 1a 2b 1a 2b 04 e8 7b c8 55 aa 05 5a 00 01 |
| 0030   | 00 01 1c 20 00 00 62 3d 93 e6 00 01 5a d5 00 00 |
| 0040   | 00 00 00 00 00 00 00 00 00 04 00 00 00 00 00    |
| 0050   | 00 00 00 00 00 00 00 00 00 00 00 00 00 00 00    |
| 0060   | 00 00 00 00 00 00 00 00 00 00 00 00 00 00 00    |
| 0070   | 00 00 00 00 00 00 00 00 bc bc fe d1 74 0f 00 00 |
| 0080   | 02 00 00 03 00 00 0f 00 00 00 00 02 00 00 00    |
| 0090   | 00 00 00 00 00 01 00 00 00 00 00 00 00 34 00    |
| 00a0   | 00 00 00 00 02 00 00 02 00 00 01 00 00 02 00 00 |
| 00b0   | 02 00 00 02 00 00 00 00 00 0b 00 00 00 00 03    |
| 00c0   | 00 00 02 00 00 03 00 00 00 00 00 04 00 00 12 00 |
| 00d0   | 00 0b 00 00 03 00 00 00 00 00 02 00 00 03 00 00 |
| 00e0   | 03 00 00 02 00 00 00 00 00 12 00 00 00 00 00 00 |
| 00f0   | 00 00 00 00 00 01 00 00 00 00 00 00 00 00 00 00 |
| 0100   | 00 00 00 00 02 00 00 00 00 00 02 00 00 03 00 00 |
| 0110   | 00 00 00 00 00 00 00 00 00 0e 00 00 02 00 00 02 |
| 0120   | 00 00 02 00 00 02 00 00 00 00 00 04 00 00 1a 00 |
| 0130   | 00 0e 00 00 02 00 00 03 00 00 03 00 00 02 00 00 |
| 0140   | 00 00 00 00 00 00 1b 00 00 00 00 00 04 00 00 03 |
| 0150   | 00 00 02 00 00 00 00 00 04 00 00 02 00 00 00 00 |
| 0160   | 00 0f 00 00 02 00 00 02 00 00 03 00 00 00 00 00 |
| 0170   | 05 00 00 02 00 00 2e 00 00 3b 00 00 02 00 00 00 |
| 0180   | 00 00 03 00 00 01 00 00 03 00 00 04 00 00 00 00 |
| 0190   | 00 00 00 00 04 00 00 02 00 00 03 00 00 00 00 00 |

Figure 4-5 Timestamp schematic diagram

Note:

Red Box: Header ID

Yellow Box: Second Bits

Blue Box: Microsecond Bits

- The timestamps are divided into second bits and microsecond bits. The second bits shown in Figure 4-5 is 0x0000623d93e6 (1648202726); the microsecond bits is 0x00015ad5 (88789);
- The seconds part is a UTC timestamp, represents the second increment count from 0:00 on January 1, 1970 (London time) to the current time. Figure 4-5 indicates London time 2022-03-25 10:05:26;
- The maximum value of the microsecond part is 0xF423F (999999), its maximum value plus 1 after the microsecond back to zero and the second into 1. Figure 4-5 shows 88,789 microseconds;
- If the system library <time.h>, time.gmtime (&t) function Included, you can convert the timestamp to London time.

## 5 Communication Protocol

The communication between RS-Ruby Plus and computer is through Ethernet and by sending UDP packets. There are mainly two types of communication protocols, as shown in the following table:

Table 5-1 Communication Protocols

| Protocol                           | Abbreviation | Function                  | Type | Packet Size | The sending time interval |
|------------------------------------|--------------|---------------------------|------|-------------|---------------------------|
| Main data Stream Output Protocol   | MSOP         | Output measured data      | UDP  | 1248byte    | ~0.167us                  |
| Device Information Output Protocol | DIFOP        | Output sensor information | UDP  | 1248byte    | ~1s                       |

Note: The following sections describe and define the valid payload (1248byte) of the protocols.

- 1 ) The main data stream output protocol MSOP, encapsulates the distance, angle, reflectivity and other information measured by the LiDAR into a packet and outputs to the computer;
- 2 ) Device information output protocol DIFOP, outputs various configuration information of the current state LiDAR to the computer;

### 5.1 MSOP and DIFOP

The UDP packet sent by RS-Ruby Plus has a payload of 1248 bytes, the data structure of the main data stream output protocol (MSOP) and device information output protocol (DIFOP) is as shown in the figure below:

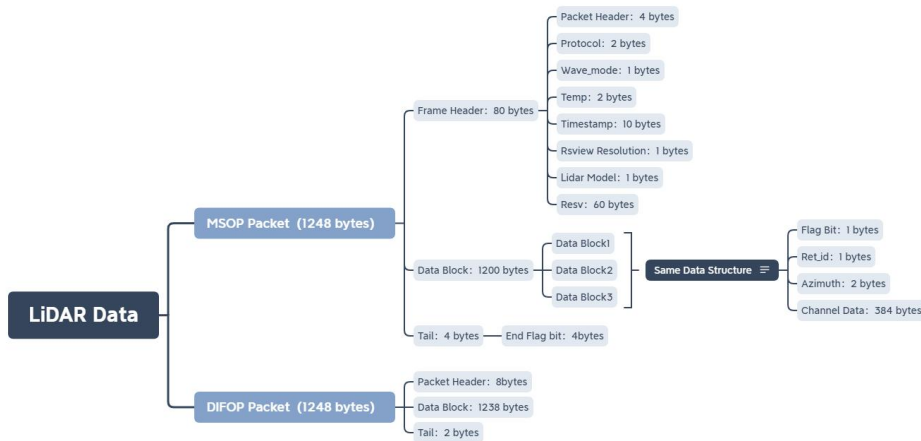

Figure 5-1 LiDAR Date Structure

## 5.2 Main Data Stream Output Protocol (MSOP)

Main data Stream Output Protocol is abbreviated as MSOP

I/O type: device output, computer analysis

Default port number: 6699

### 5.2.1 Header

The header has 80 bytes and is used to identify the beginning of the data packet. The structure of the Header is as shown in the table below:

Table 5-2 MSOP Header

| Header (80 bytes) |        |               |   |
|-------------------|--------|---------------|---|
| Field             | Offset | Length (byte) | Description   |
| Header ID         | 0      | 4             | 0x55,0xAA,0x05,0x5A,  |
| Protocol Version  | 4      | 2             | 0x01,0x02,  |
| Resv              | 6      | 1             | Reserved for future updates   |
| Wave_mode         | 7      | 1             | Big-endian mode is adopted, the lower 4 bits are used to select the echo mode, and the corresponding bit indicates whether to select the corresponding echo |
| Temp              | 8      | 2             | Sensor temperature information  |
| Timestamp         | 10     | 10            | Time stamp which is used to record system time  |
| Resv              | 20     | 11            | Reserved for future updates   |
| LiDAR Type        | 31     | 1             | Series of Lidar<br>0x05:RS-Ruby plus  |
| LiDAR Model       | 32     | 1             | 0x01:ruby_plus<br>0x02:ruby_plus_80<br>0x03:ruby_plus_80V<br>0x04:ruby_plus_48v   |
| Resv              | 33     | 47            | Reserved for future updates   |

Note: The time stamp is used to record the time of the sensor system, with a resolution of 1us. Please refer to the definition of time in Appendix B.14.

Table 5-3 Wave\_mode and Ret\_id correspondence table

| Wave_mode and Ret_id correspondence table |           |             |
|---|-----------|-------------|
| Mode \ Definition                         | Wave_mode | Ret_id      |
| single return                             | 1         | 1           |
| dual return                               | 3         | 1,2; 1,2... |

### 5.2.2 Data Blocks

As shown in the table below, the Data Blocks in the MSOP packet store the data measured by the sensor, and has a total of 1164 bytes. There are a total of 3 data blocks in one MSOP Packet. Each data block has 388 bytes and represents a complete measurement, see the following table for details:

Table 5-4 Data Blocks Definitions

| Data Block (1164 bytes) |                  |                  |
|-------------------------|------------------|------------------|
| Data Block 1            | Data Block 2     | Data Block 3     |
| 0xFE                    | 0xFE             | 0xFE             |
| Ret_id                  | Ret_id           | Ret_id           |
| Azimuth 1               | Azimuth 2        | Azimuth 3        |
| Channel data 1          | Channel data 1   | Channel data 1   |
| Channel data 2          | Channel data 2   | Channel data 2   |
| ... ..                  | ... ..           | ... ..           |
| Channel data 127        | Channel data 127 | Channel data 127 |
| Channel data 128        | Channel data 128 | Channel data 128 |

Note: In the dual return mode, the first column of 128 channels data block reports the last return data, and the second column of 128 channels data block reports the strongest return data.

#### 5.2.2.1 Channel Data

Each channel data has 3 bytes, the upper two bytes store distance information, and the lower one byte stores reflectivity information, as shown in the figure below.

Table 5-5 Channel Data

| Channel data n (3 bytes) |                 |                     |
|--------------------------|-----------------|---------------------|
| 2 byte Distance          |                 | 1 byte Reflectivity |
| Distance1 [15:8]         | Distance2 [7:0] | Reflectivity        |

Distance information contains 2 bytes, the unit is cm, the resolution is 0.5cm.





the angle encoder corresponding the zero degree of the azimuth value. The azimuth resolution is 0.01 degrees.

### 5.2.3 Tail

The Tail is 4 bytes in length, reserved for calibration.

## 5.3 Device Info Output Protocol (DIFOP)

Device Info Output Protocol is abbreviated as DIFOP

I/O type: device output, computer read.

Default port number: 7788.

DIFOP is an "output-only" protocol to periodically send the LiDAR serial number (S/N), firmware version information, host computer driver compatibility information, network configuration information, calibration information, motor operating configuration, operating status, and fault diagnosis information to users. By reading DIFOP, users can learn specific information of various parameters of the LiDAR currently in use.

A complete DIFOP packet consists of a synchronization header, data area and a tail. Each DIFOP Packet is 1248-byte long, including an 8-byte long synchronization header, 1238-byte long data blocks and a 2-byte long tail.

The basic structure of the DIFOP packet is as shown in the table below:

Table 5-6 DIFOP Packet Structure

| Segments                       | No.                         | Information Registers                | Offset | Length (byte) |
|--------------------------------|-----------------------------|--------------------------------------|--------|---------------|
| Header                         | 0                           | DIFOP identification header          | 0      | 8             |
| Data                           | 1                           | Motor speed                          | 8      | 2             |
|                                | 2                           | Ethernet source address              | 10     | 4             |
|                                |                             | Ethernet destination address         | 14     | 4             |
|                                |                             | Ethernet IP and LiDAR MAC address    | 18     | 6             |
|                                |                             | MSOP port number                     | 24     | 2             |
|                                |                             | Reserved                             | 26     | 2             |
|                                |                             | DIFOP port number                    | 28     | 2             |
|                                |                             | Reserved                             | 30     | 2             |
|                                | 3                           | The FOV start angle                  | 32     | 2             |
|                                |                             | The FOV end angle                    | 34     | 2             |
|                                | 4                           | Reserved                             | 36     | 2             |
|                                | 5                           | Motor phase lock                     | 38     | 2             |
|                                | 6                           | Top board firmware version number    | 40     | 5             |
|                                |                             | Bottom board firmware version number | 45     | 5             |
|                                |                             | Bottom board software version        | 50     | 5             |
|                                |                             | Motor firmware version number        | 55     | 5             |
| Sensor hardware version number |                             | 60                                   | 3      |               |
|                                | Web page cgi version number | 63                                   | 4      |               |

|      |    |  |      |     |
|------|----|--|------|-----|
|      |    | Reserved   | 67   | 16  |
|      | 7  | Ethernet gateway                                 | 83   | 4   |
|      | 8  | Subnet mask                                      | 87   | 4   |
|      | 9  | Reserved   | 91   | 201 |
|      | 10 | Serial number                                    | 292  | 6   |
|      | 11 | Zero angle offset                                | 298  | 2   |
|      | 12 | Return mode                                      | 300  | 1   |
|      | 13 | Time Synchronization Mode                        | 301  | 1   |
|      |    | Synchronization status                           | 302  | 1   |
|      |    | Time   | 303  | 10  |
|      | 14 | Operating status                                 | 313  | 24  |
|      | 15 | positive angle and negative angle sign positions | 337  | 1   |
|      | 16 | Total Sensor running time                        | 338  | 4   |
|      | 17 | Fault diagnosis                                  | 342  | 9   |
|      |    | Number of starts                                 | 351  | 2   |
|      |    | Reserved   | 353  | 4   |
|      |    | GPS status                                       | 357  | 1   |
|      |    | temperature monitoring                           | 358  | 10  |
|      |    | Reserved   | 368  | 1   |
|      |    | Code Wheel Calibration                           | 369  | 1   |
|      |    | Internal debug                                   | 370  | 1   |
|      |    | Motor real-time phase value                      | 371  | 2   |
|      |    | Real-time speed                                  | 373  | 2   |
|      |    | Reserved   | 375  | 7   |
|      | 18 | GPRMC  | 382  | 86  |
|      | 19 | Corrected vertical angle                         | 468  | 384 |
|      |    | Corrected horizontal angle                       | 852  | 384 |
|      | 20 | Reserved   | 1236 | 10  |
| Tail | 21 | Tail   | 1246 | 2   |

Note: The Header (the DIFOP identifier) in the table above is 0xA5,0xFF,0x00,0x5A,0x11,0x11,0x55,0x55, it can be used to identify the packet. The tail is 0x0F,0xF0.

For detailed definition of information registers as well as their usage, please refer to Appendix B of this user manual.

## 6 Vertical Angles and Precision Point Timing Calculation

### 6.1 Channel Number and Vertical Angle

RS-Ruby Plus has a vertical field of view from  $-25^{\circ}$ ~ $+15^{\circ}$ . The 128 laser heads are also called 128 channels. The laser channels and their designated vertical angles are as shown below.

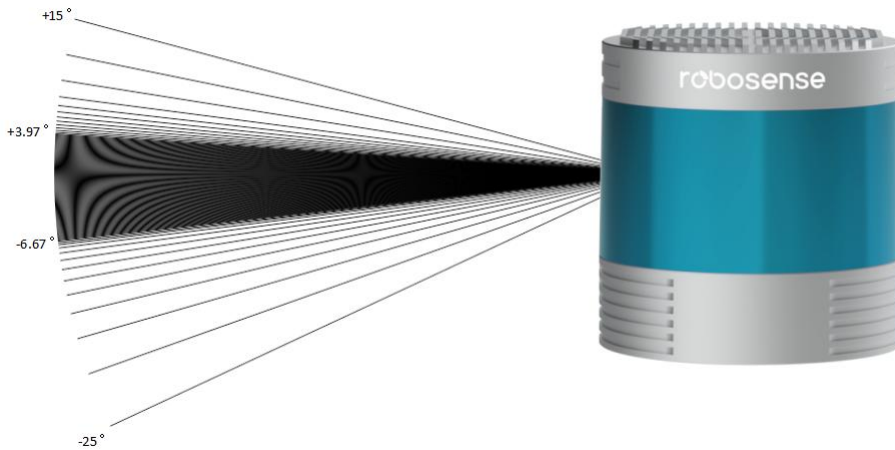

Figure 6-1 RS-Ruby\_Plus Vertical Angles

### 6.2 Exact Point Timing Calculation

The time required to complete one round of firing and recharging of 128 lasers is 55.56us. In each MSOP Packet, there are 3 data blocks, and each data block stores measurements of 1 firing sequences of 128 lasers. It takes 55.56us to complete one round of firing and recharging of the 128 lasers. Laser Channel\_ID is 1~128, the timestamp of each MSOP Packet is the time of the laser spot of the 1st channel. To calculate the time of each laser point, the time offset of each laser point needs to be added to the timestamp.

Table 6 MSOP Packet Time Offset of Exact Laser Point Timing in Single Return Mode

| Channel_ID | Vertical Angle | HorizontAngle | MSOP Packet |        |         |
|------------|----------------|---------------|-------------|--------|---------|
|            |                |               | BLOCK1      | BLOCK2 | BLOCK3  |
| 1          | -11.78         | 5.94          | 0           | 55.56  | 111.112 |
| 2          | -10.37         | 2.39          | 0           | 55.56  | 111.112 |
| 3          | -9.27          | -1.15         | 0           | 55.56  | 111.112 |
| 4          | -8.38          | -4.69         | 0           | 55.56  | 111.112 |
| 5          | -16.07         | 4.70          | 1.217       | 56.773 | 112.329 |
| 6          | -25.10         | 1.17          | 1.217       | 56.773 | 112.329 |
| 7          | -19.64         | -2.38         | 1.217       | 56.773 | 112.329 |

|    |        |       |        |         |         |
|----|--------|-------|--------|---------|---------|
| 8  | -13.61 | -5.92 | 1.217  | 56.773  | 112.329 |
| 9  | -6.52  | 5.94  | 2.434  | 57.99   | 113.546 |
| 10 | -6.40  | 2.39  | 2.434  | 57.99   | 113.546 |
| 11 | -6.31  | -1.15 | 2.434  | 57.99   | 113.546 |
| 12 | -6.21  | -4.69 | 2.434  | 57.99   | 113.546 |
| 13 | -7.67  | 4.72  | 3.652  | 59.208  | 114.764 |
| 14 | -7.17  | 1.18  | 3.652  | 59.208  | 114.764 |
| 15 | -6.87  | -2.36 | 3.652  | 59.208  | 114.764 |
| 16 | -6.67  | -5.91 | 3.652  | 59.208  | 114.764 |
| 17 | -5.71  | 5.94  | 4.869  | 60.425  | 115.981 |
| 18 | -5.60  | 2.39  | 4.869  | 60.425  | 115.981 |
| 19 | -5.51  | -1.15 | 4.869  | 60.425  | 115.981 |
| 20 | -5.41  | -4.69 | 4.869  | 60.425  | 115.981 |
| 21 | -6.10  | 4.72  | 6.086  | 616.642 | 117.198 |
| 22 | -6.01  | 1.18  | 6.086  | 616.642 | 117.198 |
| 23 | -5.91  | -2.36 | 6.086  | 616.642 | 117.198 |
| 24 | -5.81  | -5.91 | 6.086  | 616.642 | 117.198 |
| 25 | -4.90  | 5.94  | 7.304  | 62.86   | 118.416 |
| 26 | -4.80  | 2.39  | 7.304  | 62.86   | 118.416 |
| 27 | -4.70  | -1.15 | 7.304  | 62.86   | 118.416 |
| 28 | -4.60  | -4.69 | 7.304  | 62.86   | 118.416 |
| 29 | -5.30  | 4.72  | 8.521  | 64.077  | 119.633 |
| 30 | -5.20  | 1.18  | 8.521  | 64.077  | 119.633 |
| 31 | -5.10  | -2.36 | 8.521  | 64.077  | 119.633 |
| 32 | -5.00  | -5.91 | 8.521  | 64.077  | 119.633 |
| 33 | -4.10  | 5.94  | 9.739  | 65.295  | 120.851 |
| 34 | -4.00  | 2.39  | 9.739  | 65.295  | 121.851 |
| 35 | -3.90  | -1.15 | 9.739  | 65.295  | 122.851 |
| 36 | -3.80  | -4.69 | 9.739  | 65.295  | 123.851 |
| 37 | -4.50  | 4.72  | 11.323 | 66.879  | 122.435 |
| 38 | -4.40  | 1.18  | 11.323 | 66.879  | 122.435 |
| 39 | -4.30  | -2.36 | 11.323 | 66.879  | 122.435 |
| 40 | -4.20  | -5.91 | 11.323 | 66.879  | 122.435 |
| 41 | -3.30  | 5.94  | 12.907 | 68.463  | 124.019 |
| 42 | -3.20  | 2.39  | 12.907 | 68.463  | 124.019 |
| 43 | -3.10  | -1.15 | 12.907 | 68.463  | 124.019 |
| 44 | -3.00  | -4.69 | 12.907 | 68.463  | 124.019 |
| 45 | -3.70  | 4.72  | 14.924 | 70.48   | 126.036 |
| 46 | -3.60  | 1.18  | 14.924 | 70.48   | 126.036 |
| 47 | -3.50  | -2.36 | 14.924 | 70.48   | 126.036 |
| 48 | -3.40  | -5.90 | 14.924 | 70.48   | 126.036 |
| 49 | -2.50  | 5.94  | 16.941 | 72.497  | 128.053 |
| 50 | -2.39  | 2.39  | 16.941 | 72.497  | 128.053 |

|    |       |       |        |        |         |
|----|-------|-------|--------|--------|---------|
| 51 | -2.30 | -1.15 | 16.941 | 72.497 | 128.053 |
| 52 | -2.20 | -4.69 | 16.941 | 72.497 | 128.053 |
| 53 | -2.90 | 4.72  | 18.959 | 74.515 | 130.071 |
| 54 | -2.80 | 1.18  | 18.959 | 74.515 | 130.071 |
| 55 | -2.70 | -2.36 | 18.959 | 74.515 | 130.071 |
| 56 | -2.60 | -5.90 | 18.959 | 74.515 | 130.071 |
| 57 | -1.69 | 5.94  | 20.976 | 76.532 | 132.088 |
| 58 | -1.59 | 2.39  | 20.976 | 76.532 | 132.088 |
| 59 | -1.49 | -1.15 | 20.976 | 76.532 | 132.088 |
| 60 | -1.39 | -4.69 | 20.976 | 76.532 | 132.088 |
| 61 | -2.09 | 4.72  | 23.127 | 78.683 | 134.239 |
| 62 | -2.00 | 1.18  | 23.127 | 78.683 | 134.239 |
| 63 | -1.90 | -2.36 | 23.127 | 78.683 | 134.239 |
| 64 | -1.80 | -5.90 | 23.127 | 78.683 | 134.239 |
| 65 | -0.89 | 5.94  | 25.278 | 80.834 | 136.390 |
| 66 | -0.79 | 2.39  | 25.278 | 80.834 | 136.390 |
| 67 | -0.69 | -1.15 | 25.278 | 80.834 | 136.390 |
| 68 | -0.59 | -4.69 | 25.278 | 80.834 | 136.390 |
| 69 | -1.29 | 4.72  | 27.428 | 82.984 | 138.54  |
| 70 | -1.19 | 1.18  | 27.428 | 82.984 | 138.54  |
| 71 | -1.09 | -2.36 | 27.428 | 82.984 | 138.54  |
| 72 | -0.99 | -5.90 | 27.428 | 82.984 | 138.54  |
| 73 | -0.09 | 5.94  | 29.579 | 85.135 | 140.691 |
| 74 | 0.01  | 2.39  | 29.579 | 85.135 | 140.691 |
| 75 | 0.11  | -1.15 | 29.579 | 85.135 | 140.691 |
| 76 | 0.21  | -4.69 | 29.579 | 85.135 | 140.691 |
| 77 | -0.49 | 4.72  | 31.963 | 87.519 | 143.075 |
| 78 | -0.39 | 1.18  | 31.963 | 87.519 | 143.075 |
| 79 | -0.29 | -2.36 | 31.963 | 87.519 | 143.075 |
| 80 | -0.19 | -5.90 | 31.963 | 87.519 | 143.075 |
| 81 | 0.71  | 5.94  | 34.347 | 89.903 | 145.459 |
| 82 | 0.81  | 2.39  | 34.347 | 89.903 | 145.459 |
| 83 | 0.91  | -1.15 | 34.347 | 89.903 | 145.459 |
| 84 | 1.01  | -4.69 | 34.347 | 89.903 | 145.459 |
| 85 | 0.31  | 4.72  | 36.498 | 92.054 | 147.61  |
| 86 | 0.41  | 1.18  | 36.498 | 92.054 | 147.61  |
| 87 | 0.51  | -2.36 | 36.498 | 92.054 | 147.61  |
| 88 | 0.61  | -5.90 | 36.498 | 92.054 | 147.61  |
| 89 | 1.51  | 5.94  | 38.648 | 94.204 | 149.76  |
| 90 | 1.61  | 2.39  | 38.648 | 94.204 | 149.76  |
| 91 | 1.71  | -1.15 | 38.648 | 94.204 | 149.76  |
| 92 | 1.82  | -4.69 | 38.648 | 94.204 | 149.76  |
| 93 | 1.11  | 4.72  | 40.666 | 96.222 | 151.778 |

|     |       |       |        |         |         |
|-----|-------|-------|--------|---------|---------|
| 94  | 1.21  | 1.18  | 40.666 | 96.222  | 151.778 |
| 95  | 1.31  | -2.36 | 40.666 | 96.222  | 151.778 |
| 96  | 1.41  | -5.90 | 40.666 | 96.222  | 151.778 |
| 97  | 2.32  | 5.94  | 42.683 | 98.239  | 153.795 |
| 98  | 2.41  | 2.39  | 42.683 | 98.239  | 153.795 |
| 99  | 2.52  | -1.15 | 42.683 | 98.239  | 153.795 |
| 100 | 2.62  | -4.69 | 42.683 | 98.239  | 153.795 |
| 101 | 1.91  | 4.72  | 44.267 | 99.823  | 155.379 |
| 102 | 2.02  | 1.18  | 44.267 | 99.823  | 155.379 |
| 103 | 2.12  | -2.36 | 44.267 | 99.823  | 155.379 |
| 104 | 2.22  | -5.90 | 44.267 | 99.823  | 155.379 |
| 105 | 3.12  | 5.94  | 45.851 | 101.407 | 156.963 |
| 106 | 3.22  | 2.39  | 45.851 | 101.407 | 156.963 |
| 107 | 3.32  | -1.15 | 45.851 | 101.407 | 156.963 |
| 108 | 3.42  | -4.69 | 45.851 | 101.407 | 156.963 |
| 109 | 2.72  | 4.72  | 47.435 | 102.991 | 158.547 |
| 110 | 2.82  | 1.18  | 47.435 | 102.991 | 158.547 |
| 111 | 2.92  | -2.36 | 47.435 | 102.991 | 158.547 |
| 112 | 3.02  | -5.90 | 47.435 | 102.991 | 158.547 |
| 113 | 3.97  | 5.94  | 49.019 | 104.575 | 160.131 |
| 114 | 4.17  | 2.39  | 49.019 | 104.575 | 160.131 |
| 115 | 4.42  | -1.15 | 49.019 | 104.575 | 160.131 |
| 116 | 4.72  | -4.69 | 49.019 | 104.575 | 160.131 |
| 117 | 3.52  | 4.72  | 50.603 | 106.159 | 161.715 |
| 118 | 3.62  | 1.18  | 50.603 | 106.159 | 161.715 |
| 119 | 3.72  | -2.36 | 50.603 | 106.159 | 161.715 |
| 120 | 3.82  | -5.91 | 50.603 | 106.159 | 161.715 |
| 121 | 7.43  | 5.94  | 52.187 | 107.743 | 163.299 |
| 122 | 9.02  | 2.39  | 52.187 | 107.743 | 163.299 |
| 123 | 11.53 | -1.15 | 52.187 | 107.743 | 163.299 |
| 124 | 15.04 | -4.70 | 52.187 | 107.743 | 163.299 |
| 125 | 5.07  | 4.72  | 53.771 | 109.327 | 164.883 |
| 126 | 5.48  | 1.18  | 53.771 | 109.327 | 164.883 |
| 127 | 5.98  | -2.36 | 53.771 | 109.327 | 164.883 |
| 128 | 6.58  | -5.91 | 53.771 | 109.327 | 164.883 |

Note: In the dual return mode, the 128-channel data in the odd-numbered column of the Data Block stores the last return, and the 128-channel data in the integer column stores the strongest return.

## 7 Troubleshooting

When using the sensor, users may encounter some common problems, this chapter lists some common problems and the corresponding solutions.

| Problem   | Solution  |
|---|---|
| The red LED indicator in the Interface Box is off or blinking | <ul style="list-style-type: none"> <li>● Check whether the input power connection and polarity are normal.</li> </ul>   |
| LiDAR motor does not rotate                                   | <ul style="list-style-type: none"> <li>● Check whether the LED indicators on the Interface Box are normal.</li> <li>● Check if the connection cable between the Interface Box and the LiDAR gets loose.</li> </ul>  |
| LiDAR keeps restarting at startup                             | <ul style="list-style-type: none"> <li>● Check whether the input power connection and polarity are normal.</li> <li>● Check whether the voltage and current of the input power supply meet the requirements (voltage input<math>\leq</math>12V, input current<math>\geq</math>3.3A).</li> <li>● Check whether the mounting base of the device is level or whether the fixing screws at the bottom of the LiDAR are too tight.</li> </ul>  |
| LiDAR rotates but no data output                              | <ul style="list-style-type: none"> <li>● Check whether the network connection is normal.</li> <li>● Check whether the computer network configuration is correct.</li> <li>● Use another software (such as wireshark) to check whether the packet output is normal.</li> <li>● Turn off firewalls and other security software that may block the network.</li> <li>● Check whether the power supply is normal</li> <li>● Try to restart the sensor</li> </ul>  |
| Can see data in Wireshark but not in RSVIEW                   | <ul style="list-style-type: none"> <li>● Turn off the computer firewall, and allow the RSVIEW to bypass the firewall.</li> <li>● Make sure that the IP of the computer is consistent with the IP of the LiDAR.</li> <li>● Make sure that the Data Port setting on RSVIEW is correct.</li> <li>● Make sure that the RSVIEW installation directory or configuration file storage directory only contain English characters.</li> <li>● Make sure that the data packets received by wireshark are MSOP packets.</li> </ul> |
| Frequent data dropouts  | <ul style="list-style-type: none"> <li>● Check whether there is excessive traffic and/or collisions on network.</li> <li>● Check whether there are other network devices in the network sending excessive broadcast packets, which slows the sensor down.</li> <li>● Check whether the computer or the interfaces meets the packet flow requirements.</li> <li>● Remove all other network devices and directly connect sensor to the computer to test whether there is packet loss.</li> </ul>                          |



|   |   |
|---|---|
| <p>GPS/PTP not synchronizing</p>  | <ul style="list-style-type: none"> <li>● Make sure that the synchronization mode has been switched to the correct mode on the web page</li> <li>● Make sure that the GPS baud rate is 9600bps and serial port set to 8N1 (8 bits, no parity, 1 stop bit).</li> <li>● Check whether the GPS signal level is 3.3V TTL or RS232</li> <li>● Make sure that the 1PPS pulse is continuous and the connection is correct</li> <li>● Make sure that the GPRMC message of NMEA is correct</li> <li>● Make sure that the GPS and Interface Box share the same ground</li> <li>● Make sure that the GPS has received valid message</li> <li>● Make sure that the GPS module is outdoors</li> <li>● Check if the PTP Master synchronization protocol complies with the current PTP protocol</li> <li>● Check if the PTP Master is working properly</li> </ul> |
| <p>No data output when sensor connected to a router</p>                       | <ul style="list-style-type: none"> <li>● Turn off the DHCP function of the router or set the IP of the sensor to the correct IP inside the router</li> </ul>  |
| <p>the point cloud, there is a fixed blank area that continuously rotates</p> | <ul style="list-style-type: none"> <li>● This phenomenon is normal, because the ROS driver performs frame display according to a fixed number of packets, and the blank part of the data will be displayed in the next frame</li> </ul>   |
| <p>RSVIEW software outputs point cloud into a ray</p>                         | <ul style="list-style-type: none"> <li>● If you are using a windows 10 system, please set RSVIEW to run in the mode compatible with windows 7</li> </ul>  |

## Appendix A Web Interface

RS-Ruby Plus can only be accessed and controlled by its Web Interface, through which users can perform various operations on the RS-Ruby Plus, including setting LiDAR parameters, viewing LiDAR operation status, updating firmware, etc.

RS-Ruby Plus web address changes with the Device IP. The factory default Device IP is 192.168.1.200. If the user has changed the Device IP, the web address will be changed to the newly set IP address.

After the LiDAR is connected and the correct configuration is completed according to the requirements, use the computer browser to access the Device IP address (default Device IP "192.168.1.200") and enter the LiDAR web homepage, the homepage defaults to the "Device" page.

### A.1 Device Screen

After accessing the LiDAR Web Interface, you will be at the "Device" screen directly, which shows information of the LiDAR currently in use:

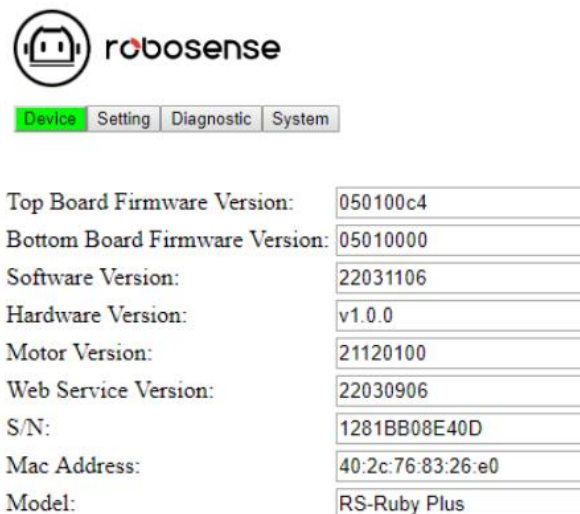

Figure A-1 Front Page of Web Interface

### A.2 Web Interface for Sensor Setting

Click the **Setting** button on the Web Interface, you will open the "Setting" screen, where you will find settings for Device IP, port number, return mode, rotation speed, etc. Definition of the functionality and features are as shown in the below:

The screenshot shows the 'General Setting' page of the Robosense LiDAR web interface. At the top, there is a navigation bar with 'Device', 'Setting' (highlighted), 'Diagnostic', and 'System'. Below this, there are two tabs: 'General Setting' and 'Angle Pulse Setting'. The 'General Setting' tab is active, displaying a list of configuration parameters:

- Device IP Address: 192.168.1.201
- Device IP Mask: 255.255.255.0
- Device IP Gateway: 192.168.1.1
- Destination IP Address: 192.168.1.102
- MSOP Port Number(1025~65535): 6699
- DIFOP Port Number(1025~65535): 7788
- Return Mode: Strong (dropdown menu)
- FOV Setting(0~360): 0 to 360 DEG
- Time Synchronization Source: PTP-GPTP (dropdown menu)
- Operation Mode: High Performance (dropdown menu)
- Phase Lock Setting(0~360): 0 DEG
- Rotation Speed: 600 (dropdown menu)
- Motor Reversal:  ON
- Restore Default:  ON

A 'Save' button is located at the bottom of the form.

Figure a-2.1 General Setting Page of the LiDAR Web Interface

- 1.Communication of LiDAR supports both unicast (default) and broadcast modes. Destination IP address 255.255.255.255 indicates broadcast mode. The default factory setting of the LiDAR IP is 192.168.1.102;
- 2.The MSOP and DIFOP port numbers can be configured in a range from 1025 to 65535;
- 3.The Return Mode has 6 options: Strongest(default), Last, First, Last and Strongest, First and Strongest, first and last;
- 4.The FOV can be set from 0° to 360°, when set, only the point cloud of the set FOV will be output;
- 5.The Time Synchronization Source has options: GPS, P2P, E2E (default) and GPTP;
- 6.Click the dropdown menu of "Operation Mode", users can select the working mode between Standby and High Performance (default). When Standby mode is selected, the LiDAR motor and transmitter will stop working; When High Performance mode is selected, the horizontal resolution becomes 0.1°;
- 7.The phase locking value can be set from 0 to 359;
- 8.The sensor rotation speed can be set, which only 300rpm, 600rpm(default), and 1200rpm are supported at the moment;
- 9.Motor Reversal: Check on and save, the motor will rotate counterclockwise;
- 10.Restore Default: Check the function and save, the current configuration will be restored to the default setting;

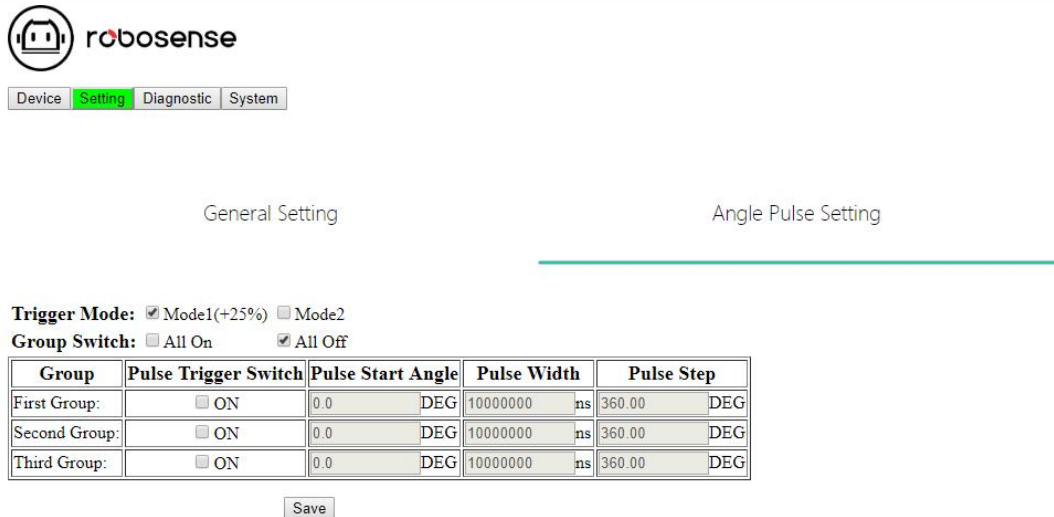

Figure A-3 Angle Pulse Setting Page of the LiDAR Web Interface

- 1.Angle Pulse Setting:** Set the angle pulse triggering feature, which by default is turned off;
- 2.Trigger Mode :** There are two starting angle trigger modes. Mode1 means that the starting pulse width is increased by 25% (default), and Mode2 means that the starting pulse width is not increased;
- 3.Group Switch:** Turn on/off the "Pulse Trigger Switch", when "All On" is checked, all groups of SYNC angle pulse trigger settings are activated for setting. The Group Switch is by default checked "All Off";
- 4.Group:** Referring to SYNC OUT group. The RS-Ruby Plus integrated sensor cable has reserved three SYNC pins, but the Interface Box has no pin(Contact our sales or technical support if necessary). Please refer to Figure 3 version 3.0.0" for more details.
- 5.Pulse Trigger Switch:** Turn on /off the "Pulse Trigger Switch" of a specific group of SYNC angle pulse trigger settings, when "ON" is checked, the settings are activated for editing, when not checked, the settings turn grey and are not editable.
- 6.Pulse Start Angle :** Setting the starting angle, the default value is 0, and the resolution is 0.1 degrees.
- 7.Pulse Width:** Setting the pulse width, the default value is 10ms, and the resolution is 20ns, the maximum duty cycle is 35%;
- 8.Pulse Step:** Setting the pulse step pitch, the default value is 360 degrees, and the resolution is 0.05°.

Note:

1. The Device IP and the Destination PC IP must share the same network segment, otherwise the connection won't be successful;
2. The MSOP and DIFOP port number can be set from 1025 to 65535;
3. After every modification of the settings, you will need to click the "Save" button, if the system prompts "setting is successful", the new settings will take effect.

### A.3 Diagnostic Screen

Click the **Diagnostic** button on the front page of the Web Interface, you will see the **Diagnostic Screen**, where you can learn the operating status of the sensor in real time, including the input voltage, current, sensor rotating speed, operating time, and temperature. The figure below shows the image of the Diagnostic screen and the features:

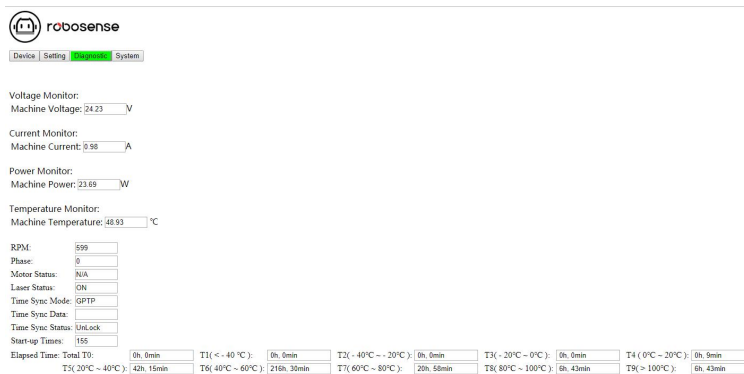

Figure A-4 Diagnostic Screen of the Web Interface

1. **Voltage Monitor** shows the voltage of the sensor input power supply in real time;
2. **Current Monitor** is the device current, and in Standby mode, the current here will be reduced to about 0.2A;
3. **Power Monitor** is the device power consumption, and in Standby mode, the power consumption will be reduced to about 5W;
4. Users can view the current operating temperature of the LiDAR;
5. **RPM** shows the LiDAR rotating speed in real time;
6. **Phase** can view the current angle phase;
7. **Laser Status:** users can choose from "ON" (default) or "OFF", if the LiDAR Operation Mode is set in the Standby mode, the laser status is "OFF";
8. **Time Sync Mode** can view the current time synchronization mode;
9. **Time Sync Status** can view the current time synchronization status;

10.**Start-up Times:** users can learn the total number of start-up times of the LiDAR up to date, each power circle counts 1 star-up;

11.**Elapsed time Total TO:** users can view the total operating time of the LiDAR and the total operating time under different temperature range respectively.

Note:

1. The diagnostic screen is refreshed every second.
2. If the voltage/current box turns red, please check whether the LiDAR is currently in Standby mode, if not, check whether the LiDAR is working normally;
3. The number of start-up times is refreshed after 1 minute after the LiDAR is circle powered again, and the total running time is 1min once within 10min, and 30min once after 10min.

### A.4 System Screen

Click the **System** button on the front page of the Web Interface, you will see the **System Screen**, where you can update. The operation is as shown below:

1.Prepare the Top Board firmware that is going to be used for the update and click the **Choose File** button.

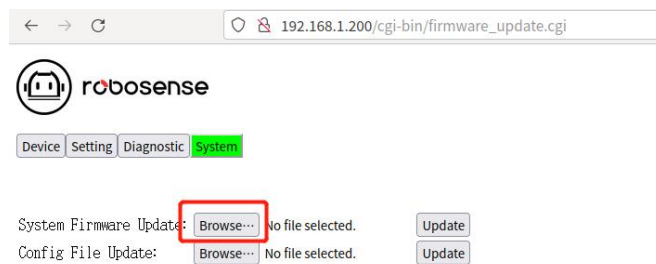

Figure A-5 Upgrade interface

2.Select the right firmware that is going to be used for the update, and click **Open** to upload the file.

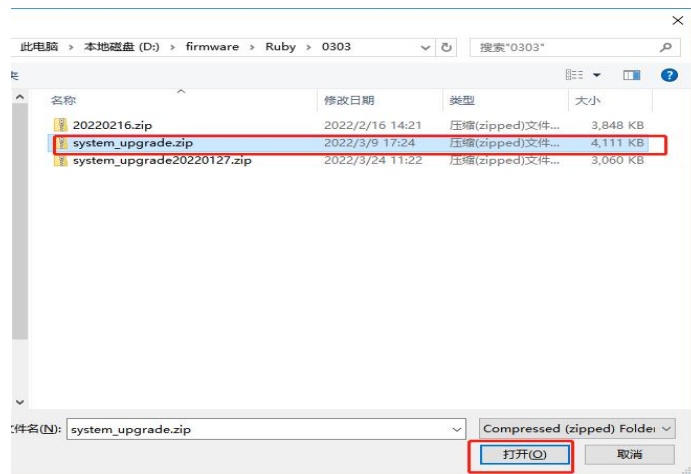

Figure A-6 Select the Right Firmware

3. When the new firmware is successfully uploaded, the file name of the firmware will appear in the box behind the bottom Board Firmware Update, click **Update** to initiate the update process

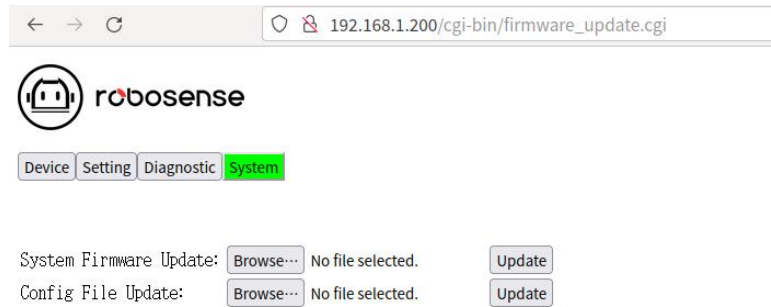

Figure A-7 Click Update

4. After the Update process completes, the Web Interface will prompt Update Successful, after the sensor is restarted, load the Web Interface again to check if the firmware update is successful.

```
Start download files >>>
System Firmware is Upgrading...
Upgrading >>> 10%
Upgrading >>> 15%
Upgrading >>> 20%
Upgrading >>> 30%
Upgrading >>> 40%
Upgrading >>> 45%
```

Figure A-8 Update Successful

## Appendix B Information Registers

Here are definitions and more details on the information registers as mentioned in Section 5.

### B.1 Motor Speed (MOT\_SPD)

| MOT_SPD (2 bytes in total) |         |       |  |  |  |  |
|----------------------------|---------|-------|--|--|--|--|
| Byte No.                   | byte1   | byte2 |  |  |  |  |
| Function                   | MOT_SPD |       |  |  |  |  |

Register description:

- (1) This register is used to configure the motor rotation direction and motor speed;
- (2) The data storage adopts the big-endian format.
- (3) Supported rotation speed:

(byte1==0x04) && (byte2==0xB0): speed 1200rpm, clockwise rotation;

(byte1==0x02) && (byte2==0x58): speed 600rpm, clockwise rotation;

(byte1==0x01) && (byte2==0x2C): speed 300rpm, clockwise rotation;

If set with data other than the above described, the rotation speed of the motor is 0

### B.2 Ethernet (ETH)

| ETH (22 bytes in total) |          |        |        |        |            |        |        |        |  |
|-------------------------|----------|--------|--------|--------|------------|--------|--------|--------|--|
| Byte No.                | byte1    | byte2  | byte3  | byte4  | byte5      | byte6  | byte7  | byte8  |  |
| Function                | LIDAR_IP |        |        |        | DEST_PC_IP |        |        |        |  |
| Byte No.                | byte9    | byte10 | byte11 | byte12 | byte13     | byte14 | byte15 | byte16 |  |
| Function                | MAC_ADDR |        |        |        |            |        | port1  |        |  |
| Byte No.                | byte17   | byte18 | byte19 | byte20 | byte21     | byte22 |        |        |  |
| Function                | port2    |        | port3  |        | port4      |        |        |        |  |

Register description:

- (1) LIDAR\_IP is the source IP address of the LiDAR. It takes 4 bytes;
- (2) DEST\_PC\_IP is the IP address of the destination PC. It takes 4 bytes;
- (3) MAC\_ADDR is the LiDAR MAC address;
- (4) port1 to port4 are port number information;

port1 is the port for LiDAR to output MSOP packets and port2 is the port for destination PC to receive MSOP packets. port3 is the port for LiDAR to output DIFOP packets and port4 is the port for destination PC to receive DIFOP packets. By default, we suggest port1 and port2 to be set the same, port3 and port4 to be set the same.

o



### B.3 FOV Setting (FOV\_SET)

| FOV_SET (4 bytes in total) |           |       |         |       |  |  |
|----------------------------|-----------|-------|---------|-------|--|--|
| Byte No.                   | byte1     | byte2 | byte3   | byte4 |  |  |
| Function                   | FOV_START |       | FOV_END |       |  |  |

Register Description:

Set the azimuth range that the sensor can output valid data, the values of FOV\_START and FOV\_END could be any integer between 0 to 36000, corresponding 0~360°, the data storage adopts the big endian ordering. For example: byte1 = 0x5d, byte2 = 0xc0, byte3 = 0x1f, byte4 = 0x40, so:

$$\text{FOV\_START} = 93 * 256 + 192 = 24000$$

$$\text{FOV\_END} = 31 * 256 + 64 = 8000$$

Which indicates that the azimuth range for valid data output is from 240.00° to 80.00° in clockwise direction.

**Note:** In all above calculations, bytes have been converted from hexadecimal to decimal.

### B.4 Motor Phase Offset (MOT\_PHASE)

| MOT_PHASE(2 bytes in total) |           |       |  |  |  |  |
|-----------------------------|-----------|-------|--|--|--|--|
| Byte No.                    | byte1     | byte2 |  |  |  |  |
| Function                    | MOT_PHASE |       |  |  |  |  |

Register description:

This register can be used together with the PPS pulse of GPS to adjust the phase offset of the motor at the top of seconds. The value can be set from 0 to 360 corresponding 0 to 360°. The data storage adopts the big endian ordering. For example: the byte1=0x01、byte2=0x0e, so the motor phase should be 1\*256+14 = 270.

**Note:** In all above calculations, bytes have been converted from hexadecimal to decimal.

### B.5 Top Board Firmware Version (TOP\_FRM)

| FOV_SET (4 bytes in total) |         |       |       |       |       |  |
|----------------------------|---------|-------|-------|-------|-------|--|
| Byte No.                   | byte1   | byte2 | byte3 | byte4 | byte5 |  |
| Function                   | TOP_FRM |       |       |       |       |  |

Register description:

This register corresponds to the top board firmware version:

Register value: 00 02 05 07 00

Top board firmware version: 02050700

## B.6 Bottom Board Firmware Version(BOT\_FRM)

| BOT_FRM(5bytes in total) |         |       |       |       |       |  |
|--------------------------|---------|-------|-------|-------|-------|--|
| Byte No.                 | byte1   | byte2 | byte3 | byte4 | byte5 |  |
| Function                 | BOT_FRM |       |       |       |       |  |

Register description:

This register corresponds to the top board firmware version:

Register value: 00 02 04 0A 00

Bottom board firmware version: 02040A00

## B.7 Software Version(SOF\_FRM)

| SOF_FRM (5 bytes in total) |         |       |       |       |       |  |
|----------------------------|---------|-------|-------|-------|-------|--|
| Byte No.                   | byte1   | byte2 | byte3 | byte4 | byte5 |  |
| Function                   | SOF_FRM |       |       |       |       |  |

Register description:

This register corresponds to the Software Firmware version:

Register value:00 20 05 30 19

Motor firmware version: 20053019

## B.8 Web CGI Version(SOF\_FRM)

| CGI (共 4bytes) |         |       |       |       |  |  |
|----------------|---------|-------|-------|-------|--|--|
| Byte No.       | byte1   | byte2 | byte3 | byte4 |  |  |
| Function       | Web_FRM |       |       |       |  |  |

Register description:

This register corresponds to the firmware version:

Register value: Register value

Motor firmware version: 22012506

## B.9 Corrected Vertical Angle(COR\_VERT\_ANG)

| COR_VERT_ANG(96bytes in total) |                           |        |        |                           |        |        |                           |        |        |
|--------------------------------|---------------------------|--------|--------|---------------------------|--------|--------|---------------------------|--------|--------|
| Byte No.                       | byte1                     | byte2  | byte3  | byte4                     | byte5  | byte6  | byte7                     | byte8  | byte9  |
| Function                       | Channel 1 vertical angle  |        |        | Channel 2 vertical angle  |        |        | Channel 3 vertical angle  |        |        |
| Byte No.                       | byte10                    | byte11 | byte12 | byte13                    | byte14 | byte15 | byte16                    | byte17 | byte18 |
| Function                       | Channel 4 vertical angle  |        |        | Channel 5 vertical angle  |        |        | Channel 6 vertical angle  |        |        |
| Byte No.                       | byte19                    | byte20 | byte21 | byte22                    | byte23 | byte24 | byte25                    | byte26 | byte27 |
| Function                       | Channel 7 vertical angle  |        |        | Channel 8 vertical angle  |        |        | Channel 9 vertical angle  |        |        |
| Byte No.                       | byte28                    | byte29 | byte30 | byte31                    | byte32 | byte33 | byte34                    | byte35 | byte36 |
| Function                       | Channel 10 vertical angle |        |        | Channel 11 vertical angle |        |        | Channel 12 vertical angle |        |        |

|          |                            |         |         |                            |         |         |                            |         |         |
|----------|----------------------------|---------|---------|----------------------------|---------|---------|----------------------------|---------|---------|
| Byte No. | byte37                     | byte38  | byte39  | byte40                     | byte41  | byte42  | byte43                     | byte44  | byte45  |
| Function | Channel 13 vertical angle  |         |         | Channel 14 vertical angle  |         |         | Channel 15 vertical angle  |         |         |
| Byte No. | byte46                     | byte47  | byte48  | byte46                     | byte47  | byte48  | byte46                     | byte47  | byte48  |
| Function | Channel 16 vertical angle  |         |         | Channel 17 vertical angle  |         |         | Channel 18 vertical angle  |         |         |
| Byte No. | byte37                     | byte38  | byte39  | byte40                     | byte41  | byte42  | byte43                     | byte44  | byte45  |
| Function | Channel 19 vertical angle  |         |         | Channel 20 vertical angle  |         |         | Channel 21 vertical angle  |         |         |
| Byte No. | ...                        |         |         | ...                        |         |         | ...                        |         |         |
| Function | ...                        |         |         |                            |         |         |                            |         |         |
| Byte No. | byte358                    | byte359 | byte360 | byte361                    | byte362 | byte363 | byte364                    | byte365 | byte366 |
| Function | Channel 120 vertical angle |         |         | Channel 121 vertical angle |         |         | Channel 122 vertical angle |         |         |
| Byte No. | byte367                    | byte368 | byte369 | byte370                    | byte371 | byte372 | byte373                    | byte374 | byte375 |
| Function | Channel 123 vertical angle |         |         | Channel 124 vertical angle |         |         | Channel 125 vertical angle |         |         |
| Byte No. | byte376                    | byte377 | byte378 | byte379                    | byte380 | byte381 | byte382                    | byte383 | byte384 |
| Function | Channel 126 vertical angle |         |         | Channel 127 vertical angle |         |         | Channel 128 vertical angle |         |         |

Register description:

- (1) The channel vertical angle value is composed of 3 bytes, among which the 1<sup>st</sup> byte is used to indicate positive/negative angle, the 2<sup>nd</sup> and 3<sup>rd</sup> bytes indicate angle value. The data storage adopts big-endian format;
- (2) The 1<sup>st</sup> byte of the vertical angle value, 0x00 means a positive angle, 0x01 means a negative angle;
- (3) The angle resolution: LBS=0.01;
- (4) For example, the register value of channel 1: byte1=0x01, byte2=0x05(converted to decimal is 5), byte3=0xd6(converted to decimal is 76), then the vertical angle of channel 1 is:  $(5 * 256 + 76) * 0.01 = 13.56^\circ$ .

### B.10 Corrected Horizontal Angle(COR\_HOR\_ANG)

| COR_HOR_ANG(384 bytes in total) |                             |        |        |                             |        |        |                             |        |        |
|---------------------------------|-----------------------------|--------|--------|-----------------------------|--------|--------|-----------------------------|--------|--------|
| Byte No.                        | byte1                       | byte2  | byte3  | byte4                       | byte5  | byte6  | byte7                       | byte8  | byte9  |
| Function                        | Channel 1 horizontal angle  |        |        | Channel 2 horizontal angle  |        |        | Channel 3 horizontal angle  |        |        |
| Byte No.                        | byte10                      | byte11 | byte12 | byte13                      | byte14 | byte15 | byte16                      | byte17 | byte18 |
| Function                        | Channel 4 horizontal angle  |        |        | Channel 5 horizontal angle  |        |        | Channel horizontal angle    |        |        |
| Byte No.                        | byte19                      | byte20 | byte21 | byte22                      | byte23 | byte24 | byte25                      | byte26 | byte27 |
| Function                        | Channel 7 horizontal angle  |        |        | Channel 8 horizontal angle  |        |        | Channel 9 horizontal angle  |        |        |
| Byte No.                        | byte28                      | byte29 | byte30 | byte31                      | byte32 | byte33 | byte34                      | byte35 | byte36 |
| Function                        | Channel 10 horizontal angle |        |        | Channel 11 horizontal angle |        |        | Channel 12 horizontal angle |        |        |
| Byte No.                        | byte37                      | byte38 | byte39 | byte40                      | byte41 | byte42 | byte43                      | byte44 | byte45 |
| Function                        | Channel 13 horizontal angle |        |        | Channel 14 horizontal angle |        |        | Channel 15 horizontal angle |        |        |
| Byte No.                        | byte46                      | byte47 | byte48 | byte46                      | byte47 | byte48 | byte46                      | byte47 | byte48 |
| Function                        | Channel 16 horizontal angle |        |        | Channel 17 horizontal angle |        |        | Channel 18 horizontal angle |        |        |
| Byte No.                        | byte37                      | byte38 | byte39 | byte40                      | byte41 | byte42 | byte43                      | byte44 | byte45 |

|          |                              |         |         |                              |         |         |                              |         |         |
|----------|------------------------------|---------|---------|------------------------------|---------|---------|------------------------------|---------|---------|
| Function | Channel 19 horizontal angle  |         |         | Channel 20 horizontal angle  |         |         | Channel 21 horizontal angle  |         |         |
| Byte No. | ...                          |         |         | ...                          |         |         | ...                          |         |         |
| Function | ...                          |         |         |                              |         |         |                              |         |         |
| Byte No. | byte358                      | byte359 | byte360 | byte361                      | byte362 | byte363 | byte364                      | byte365 | byte366 |
| Function | Channel 120 horizontal angle |         |         | Channel 121 horizontal angle |         |         | Channel 122 horizontal angle |         |         |
| Byte No. | byte367                      | byte368 | byte369 | byte370                      | byte371 | byte372 | byte373                      | byte374 | byte375 |
| Function | Channel 123 horizontal angle |         |         | Channel 124 horizontal angle |         |         | Channel 125 horizontal angle |         |         |
| Byte No. | byte376                      | byte377 | byte378 | byte379                      | byte380 | byte381 | byte382                      | byte383 | byte384 |
| Function | Channel 126 horizontal angle |         |         | Channel 127 horizontal angle |         |         | Channel 128 horizontal angle |         |         |

Register description:

(1) The channel horizontal angle value is composed of 3 bytes, among which the 1<sup>st</sup> byte is used to indicate positive/negative angle, the 2<sup>nd</sup> and 3<sup>rd</sup> bytes indicate angle value. The data storage adopts big-endian format;

(2) The 1<sup>st</sup> byte of the horizontal angle value, 0x00 means a positive angle, 0x01 means a negative angle;

(3) The angle resolution: LBS=0.01;

(4) For example, the register value of channel 1: byte1=0x01, byte2=0x01 (converted to decimal is 1), byte3=0x53 (converted to decimal is 83), then the horizontal angle of channel 1 is:

$$(2*256+83) *0.01=5.95^{\circ}$$

### B.11 Serial Number(SN)

| SN(6 bytes in total) |       |       |       |       |       |       |
|----------------------|-------|-------|-------|-------|-------|-------|
| Byte No.             | 1byte | 2byte | 3byte | 4byte | 5byte | 6byte |
| Function             | SN    |       |       |       |       |       |

Similar to the MAC address, it indicates the serial number of the LiDAR with a total of 6 bytes in hexadecimal.

### B.12 Time synchronization Setting (Sync\_set)

| Sync_set (1 bytes in total) |          |
|-----------------------------|----------|
| Byte No.                    | 1byte    |
| Function                    | Sync_set |

Register description:

- 1) 00 represents GPS Time Synchronization;
- 2) 01 represents PTP-E2E Time Synchronization;
- 3) 02 represents PTP-P2P Time Synchronization;
- 4) 03 represents Gptp Time Synchronization.

### B.13 Time synchronization Status (Sync\_Status)

| Sync_Status (1 bytes in total) |             |
|--------------------------------|-------------|
| Byte No.                       | 1byte       |
| Function                       | Sync_Status |

Register description:

- 1) 00 represents synchronization success;
- 2) 01 represents synchronization failure.

### B.14 UTC Time (UTC\_TIME)

| UTC_TIME (10 bytes in total) |       |        |       |       |       |       |       |       |  |
|------------------------------|-------|--------|-------|-------|-------|-------|-------|-------|--|
| Byte No.                     | byte1 | byte2  | byte3 | byte4 | byte5 | byte6 | byte7 | byte8 |  |
| Function                     | sec   |        |       |       |       |       | us    |       |  |
| Byte No.                     | byte9 | byte10 |       |       |       |       |       |       |  |
| Function                     | us    |        |       |       |       |       |       |       |  |

Note: the range of us is from 0 to 999999.

### B.15 Rotation Direction (ROTATION)

| ROTATION (1 bytes in total) |                    |
|-----------------------------|--------------------|
| Byte No.                    | 1byte              |
| Function                    | Rotation Direction |

Register description:

- 1) 00 represents the motor rotates clockwise.
- 2) 01 represents the motor rotates counterclockwise.

### B.16 STATUS (STATUS)

| STATUS (18 bytes in total) |                |                            |                |                |                |        |                            |        |
|----------------------------|----------------|----------------------------|----------------|----------------|----------------|--------|----------------------------|--------|
| Byte No.                   | byte1          | byte2                      | byte3          | byte4          | byte5          | byte6  | byte7                      | byte8  |
| Function                   | reserved       | machine current<br>(Value) |                | Idat2 reserved |                |        | machine voltage<br>(Value) |        |
| Byte No.                   | byte9          | byte10                     | byte11         | byte12         | byte13         | byte14 | byte15                     | byte16 |
| Function                   | Internal debug |                            | Internal debug |                | Internal debug |        | Internal debug             |        |
| Byte No.                   | 17byte         | 18byte                     | 19byte         | 20byte         | 21byte         | 22byte | 23byte                     | 24byte |
| Function                   | Internal debug |                            | Internal debug |                | Internal debug |        | Reserved                   |        |

Note:[Value] is short type data (signed bit), in big endian mode.

Register description:

1) Idat is the current of the LiDAR power supply. The current value is composed of 2 bytes.

Current calculation formula:

$$Idat = Value / 100$$

For example, when byte1 = 0x00, byte2 = 0x70, the actual current value:

$$Idat = 0x70 / 100 = 1.12A$$

2) Vdat has 9 different voltage values, each voltage value has 2 bytes, calculation formula of each voltages are as below:

$$Vdat1\_reg = Value / 100 V$$

The unit above is volt (V).

### B.17 Fault Diagnosis (FALT\_DIGS)

| FALT_DIGS (40 bytes in total) |                 |                  |               |                        |               |                        |                |                 |
|-------------------------------|-----------------|------------------|---------------|------------------------|---------------|------------------------|----------------|-----------------|
| Byte No.                      | byte1           | byte2            | byte3         | byte4                  | byte5         | byte6                  | byte7          | byte8           |
| Function                      | Reserved        |                  |               |                        |               |                        |                |                 |
| Byte No.                      | byte9           | byte10           | byte11        | byte12                 | byte13        | byte14                 | byte15         | byte16          |
| Function                      | Reserved        | Number of starts |               | Internal debug         |               |                        | GPS_Status     |                 |
| Byte No.                      | byte17          | byte18           | byte19        | byte20                 | byte21        | byte22                 | byte23         | byte24          |
| Function                      | Temperature 1   |                  | Temperature 2 |                        | Temperature 3 |                        | Internal debug |                 |
| Byte No.                      | byte25          | byte26           | byte27        | byte28                 | byte29        | byte30                 | byte31         | byte32          |
| Function                      | Internal debug  |                  | Reserved      | Code Wheel Calibration | Reserved      | Real-time phase values |                | Real-time speed |
| Byte No.                      | byte33          | byte34           | byte35        | byte36                 | byte37        | byte38                 | byte39         | byte40          |
| Function                      | Real-time speed | Reserved         |               |                        |               |                        |                |                 |

Note:[Value] is short type data (signed bit), in big endian mode.

Register description:

The temperature value is composed of 2 bytes, and the calculation formula is: Value/100

### **B.18 GPRMC Data Packet-ASCII Code Data Type**

86 bytes are reserved for the GPRMC data packet. According to the length of the GPRMC message output by the external GPS module, the received GPRMC message is self-adaptively stored and can be analyzed and viewed in ASCII code.

## Appendix C RSView

This appendix gets you started with RSView. It shows you how to use the application to acquire, visualize, save, and replay your RS-Ruby Plus data. You can also use other free tools, such as Wireshark or tcp-dump. But RSView is free and relatively easy to use. The version used here is RSView3.1.19.

### C.1 Software Features

RSView provides real-time visualization of any RoboSense LiDAR data. RSView can also review pre-recorded data stored in “pcap” (Packet Capture) files, but RSView still does not support playing pcapng files. RSView displays distance measurements from a RoboSense LiDAR as point data. It supports custom-colored display of variables such as intensity-of-return, time, distance, azimuth, and laser ID. The data can be exported in CSV format. The RSView 3.1.3 or later version supports generating LAS format point cloud files, while the previous versions of RSView do not support generating point cloud files in LAS, XYZ, or PLY formats.

Functionality and features of RSView include:

- Visualize live streaming sensor data over Ethernet
- Record live sensor data to pcap files
- Visualize sensor data from a recorded pcap file
- Different types of visualization modes, such as distance, time, azimuth, etc.
- Display point data in a spreadsheet
- Export point cloud data in CSV format
- Distance measurement tool
- Display multiple frames of data simultaneously (Trailing Frames)
- Display or hide subsets of lasers
- Crop views

### C.2 Install RSView

Installer for RSView is provided for Windows 64-bit system and there is no need for other dependencies. You can download the latest installer from RoboSense website (<http://www.robosense.ai/resource>). Launch the downloaded installer and follow the instructions to finish the installation. After installation is completed, a shortcut will be generated on the desktop. Make sure the installation path only contains English characters.

### C.3 Set Up Network

As mentioned in Section 3, the LiDAR has a factory default IP address to be sent to computer.



Therefore, by default, the static IP address of the computer needs to be set to 192.168.1.102, and the subnet mask needs to be set to 255.255.255.0. In addition, you need to make sure that the RSView is not blocked by firewalls or third-party security software.

#### C.4 Visualize Streaming Sensor Data

1. Connect LiDAR to power and connect to computer by network cable.
2. Right Click to start the RSView application with **Run As Administrator**.
3. Click on **File > Open** and select **Sensor Stream** (Figure C-1).

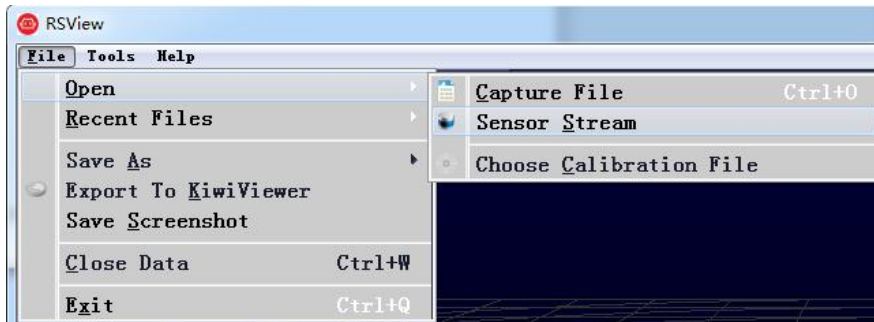

Figure C-1 RSView Open Sensor Stream

4. The Sensor Configuration dialog will appear. In "Type of Lidar", Chose RSBPearl. In "Intensity", chose Mode3. Then click **OK**, as shown in Figure C-2:

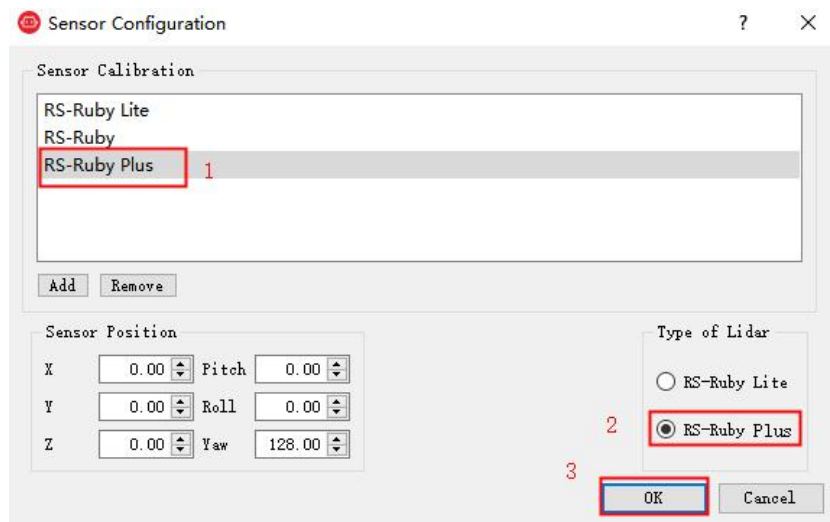

Figure C-2 Select RS-Ruby Plus Parameter Configuration File

5. Click Tools and select Sensor Network Configuration, set the MSOP port number and DIFOP port number corresponding to the radar

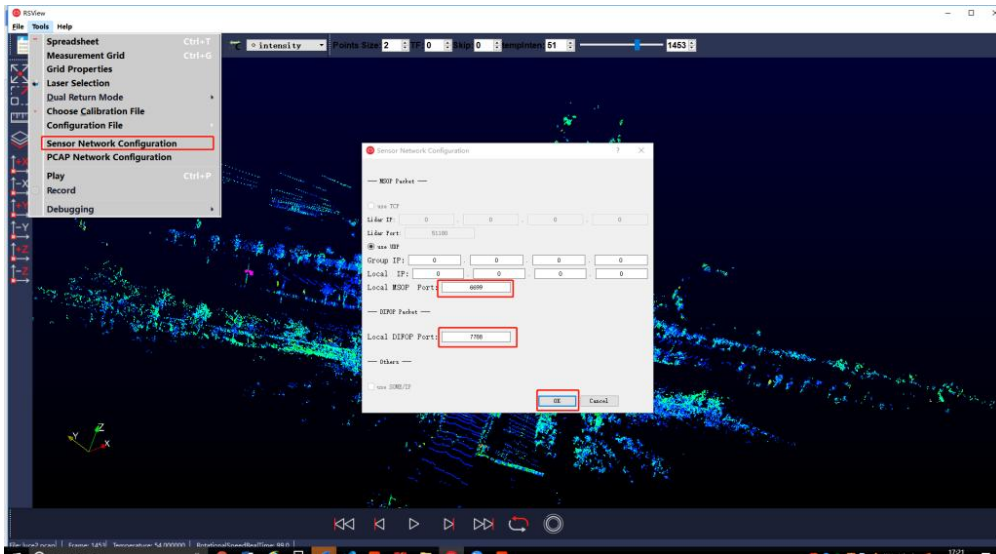

Figure C-3 Sensor Network Configuration

6. RSView begins displaying the sensor data stream (Figure C-4). The stream can be paused by pressing the **Play** button, pressing again, the stream resumes.

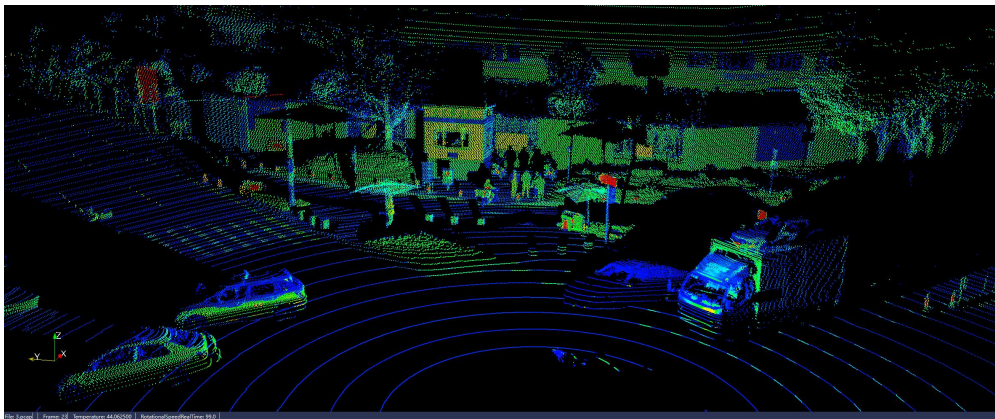

Figure C-4 Sensor Stream Data Display in RSView

### C.5 Capture Streaming Sensor Data to PCAP File

1. Click the **Record** button when streaming (Figure C-5).



Figure C-5 R RSView Record Button.

2. In the “Choose Output File” dialog that pops up, set the save path and file name, and then click the **Save (S)** button (Figure C-6). RSView will start to write the packet file into the target pcap file. (Note: RS-Ruby Plus will generate huge volume of data. As the recording time gets longer, the target pcap file will become larger. Therefore, it is better to save the recorded file to the HDD or SSD instead of a slow subsystem such as a USB drive or network drive.)

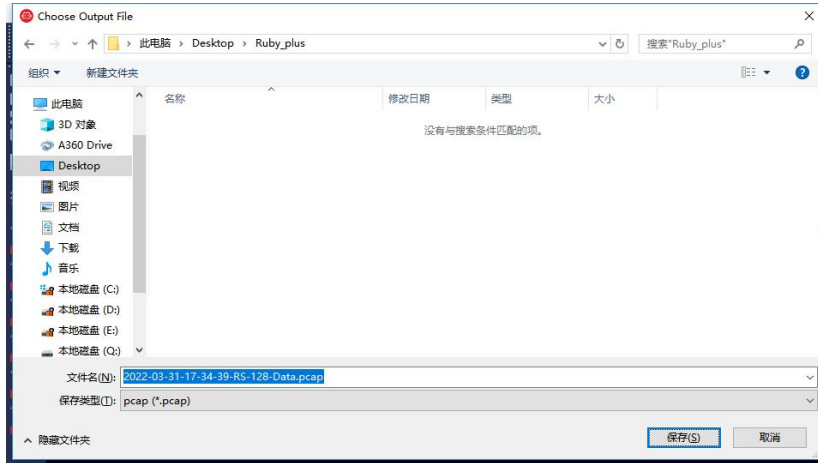

Figure C-6 RSView Record Saving Dialog.

3. Click the **Record** button again to stop saving pcap data.

### C.6 Replay PCAP File

You can use RSView to replay or verify the pcap file saved by a RS-Ruby Plus. You can press the **Play** button to play or select frames in the data that you are interested in. You can also use the mouse to select a portion of 3D point cloud which the details will then be tabulated in a spreadsheet for analysis. The saving path of the pcap file should only contain English characters.

1. Click **File > Open** and select **Capture File**

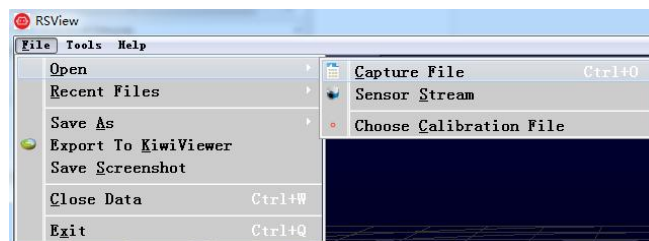

Figure C-7 Open the pcap record file

2. In the pop-up “Open File” dialog, select a recorded pcap file and click **Open (O)**

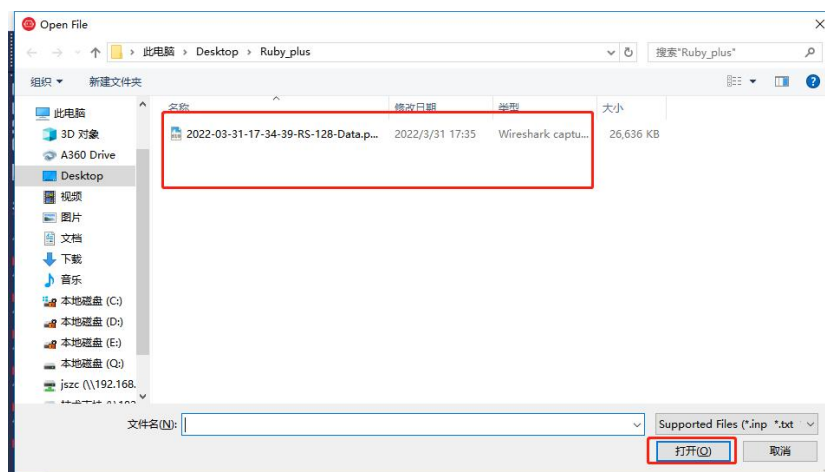

Figure C-8 Open Recorded pcap File

- In the pop-up “Sensor Configuration” dialog, add and select the correct RS-Ruby Plus configuration file and click the **OK** button.
- Click the **Play** button to play or pause the data. Use the Scrub sliding tool to slide back and forth to select frames at different positions in the data. This tool and the **Record** button are in the same toolbar (Figure C-9)



Figure C-9 RSView Play Button and Scrub Tool

- 为 In order to get a more detailed analysis, select a frame of data that you are interested in and click the **Spreadsheet** button (Figure C-10). A sidebar data table will be displayed on the right side of the screen, which contains details of all the data of this frame.



Figure C-10 RSView Spreadsheet Tool

- You can adjust the width of each column of the table, or sort to get a better view.

|    | Point ID | Points   | adjustedtime  | azimuth | distance_m | intensity | laser_id | timestamp |
|----|----------|----------|---------------|---------|------------|-----------|----------|-----------|
| 0  | 739      | 1.776... | 998301570.000 | 993     | 10.380     | 5         | 11       | 998301570 |
| 1  | 752      | 1.814... | 998301620.000 | 1011    | 10.415     | 6         | 11       | 998301620 |
| 2  | 753      | 1.820... | 998301623.000 | 1012    | 10.390     | 25        | 12       | 998301623 |
| 3  | 754      | 1.829... | 998301626.000 | 1013    | 10.390     | 13        | 13       | 998301626 |
| 4  | 766      | 1.846... | 998301670.000 | 1029    | 10.415     | 6         | 11       | 998301670 |
| 5  | 767      | 1.861... | 998301673.000 | 1030    | 10.440     | 25        | 12       | 998301673 |
| 6  | 768      | 1.861... | 998301676.000 | 1031    | 10.390     | 13        | 13       | 998301676 |
| 7  | 769      | 1.871... | 998301679.000 | 1032    | 10.410     | 33        | 14       | 998301679 |
| 8  | 780      | 1.877... | 998301720.000 | 1047    | 10.410     | 6         | 11       | 998301720 |
| 9  | 781      | 1.893... | 998301723.000 | 1048    | 10.440     | 25        | 12       | 998301723 |
| 10 | 782      | 1.896... | 998301726.000 | 1049    | 10.405     | 13        | 13       | 998301726 |
| 11 | 783      | 1.906... | 998301729.000 | 1050    | 10.425     | 40        | 14       | 998301729 |

Figure C-11 RSView Spreadsheet Display

- Click **Show only selected elements** in Spreadsheet to get the data corresponding to the selected points (Figure C-12).

|   | Point ID | Points   | adjustedtime  | azimuth | distance_m | intensity | laser_id | timestamp |
|---|----------|----------|---------------|---------|------------|-----------|----------|-----------|
| 0 | 739      | 1.776... | 998301570.000 | 993     | 10.380     | 5         | 11       | 998301570 |
| 1 | 752      | 1.814... | 998301620.000 | 1011    | 10.415     | 6         | 11       | 998301620 |

Figure C-12 RSView Show only selected elements Tool

- Click the **Select All Points** tool, which turns your mouse into a data point selection tool (Figure C-13).



Figure C-13 RSView Select All Points Tool

9. In the 3D rendered data pane, use your mouse to draw a rectangle to frame some data points. The data of these points will immediately populate the data table and the selected data points will turn pink in the data pane (Figure C-14).

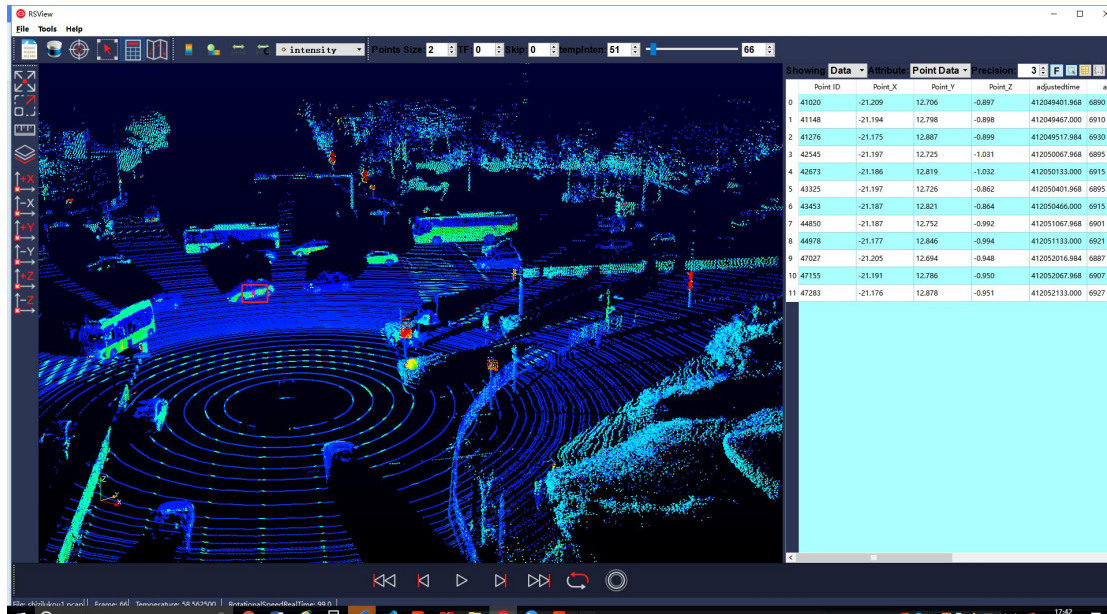

Figure C-14 RSView List Selected Points Tool

10. Any selected points can be saved via **Spreadsheet>Show only selected elements>Output CSV data**.

## Appendix D RS-Ruby Plus ROS&ROS2 Package

This appendix explains how to use Ubuntu+ROS or Ubuntu+ROS2 to acquire and visualize your RS-Ruby Plus data.

### D.1 Install Software

1. Download and install Ubuntu 16.04 or Ubuntu18.04 operating system. (ROS2 users are imperative to use the Ubuntu 18.04 system)
2. ROS users: Install and test the basic functions of ROS Kinetic according to the link (<http://wiki.ros.org/kinetic/Installation> ). (For Ubuntu 18.04 users, please install ROS-melodic)  
ROS2 users: Install and test the basic functions of ROS2 Eloquent according to the link (<https://index.ros.org/doc/ros2/Installation/Eloquent/>).
3. Download and install [libpcap-dev](#).

### D.2 Download & Compile RoboSense LiDAR Driver Package

You can get the latest LiDAR driver package from

[https://github.com/RoboSense-LiDAR/rslidar\\_sdk](https://github.com/RoboSense-LiDAR/rslidar_sdk) , or contact our technical support to get it.

After downloading, please read the **README** file in the driver package carefully, which describes in detail how to compile and use the LiDAR driver package.

rslidar\_sdk is our LiDAR driver package, which has included drivers for many RoBosense mechanical LiDAR sensors. Three compilation modes are supported:

#### 1. Direct Compilation

The user enters the main directory of the rslidar\_sdk driver package and creates a build folder to compile and run.

```
mkdir build
cd build
cmake .. && make
./rslidar_sdk_node
```

#### 2. Compilation in ROS

Create ros working directory:

```
cd ~
mkdir -p catkin_ws/src
```

Copy the rslidar\_sdk driver package to the ROS working directory ~/catkin\_ws/src. Open the CMakeLists.txt file in the rslidar\_sdk driver package, and change the set (COMPILE\_METHOD ORIGINAL) at the top of the file to set (COMPILE\_METHOD CATKIN). At the same time, rename the package\_ros1.xml file in the driver package to package.xml.

Run the following command in the terminal to compile:

```
cd ~/catkin_ws  
catkin_make
```

### 3. Compilation in ROS2

Create ros2 working directory:

```
cd ~  
mkdir -p catkin_ws/src
```

Copy the rslidar\_sdk driver package to the ROS2 working directory ~/catkin\_ws/src. Open the CMakeLists.txt file in the rslidar\_sdk driver package, and change the set (COMPILE\_METHOD ORIGINAL) at the top of the file to set (COMPILE\_METHOD COLCON). At the same time, rename the package\_ros2.xml file in the driver package to package.xml.

Run the following command in the terminal to compile:

```
cd ~/catkin_ws  
colcon build
```

## D.3 Configure PC IP

In the default RS-Ruby Plus firmware, configure the static IP address of the computer to "192.168.1.102", the subnet mask to "255.255.255.0". The gateway does not need to be configured.

After the configuration is completed, you can use the ifconfig command to check whether the static IP takes effect.

## D.4 Real Time Display

There are detailed documents in the rslidar\_sdk project to guide how to display the point cloud in real time in the ROS or ROS2 environment. Here is a brief introduction, taking the ROS environment as an example.

1. Connect RS-Ruby Plus to computer with a network cable, power it on and run, and wait for the computer to recognize the LiDAR.
2. Run the launch file provided in the rslidar\_sdk driver package to start the node program that displays data in real time. The launch file is located in rslidar\_sdk/launch/start.launch. Open a terminal and run:

```
cd ~/catkin_ws  
source devel/setup.bash  
roslaunch rslidar_sdk start.launch
```

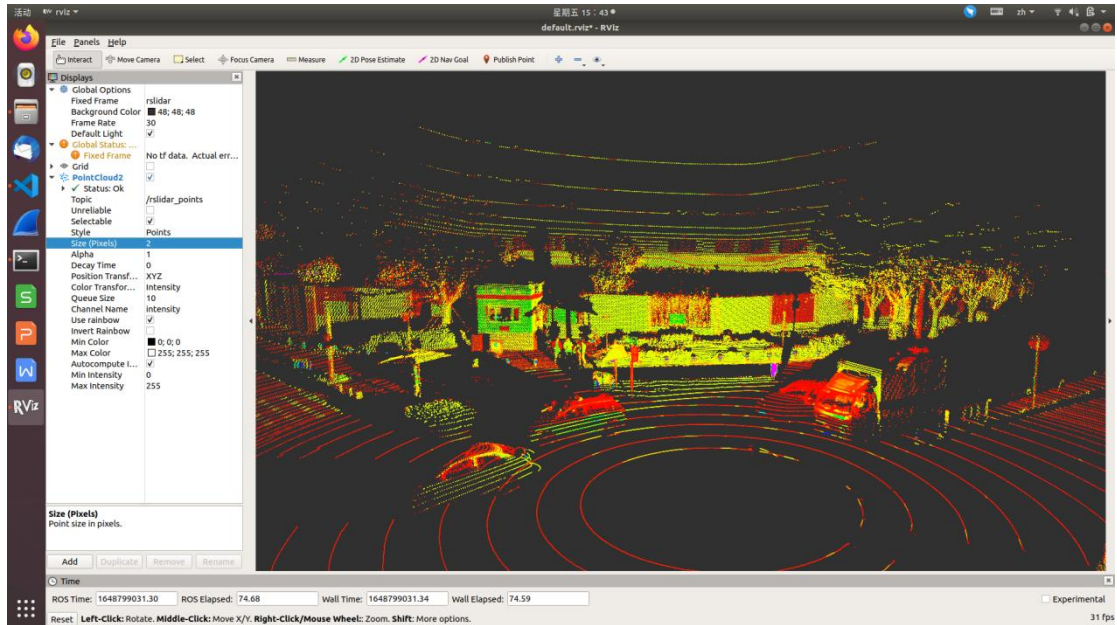

Figure D-1 rviz displays RS-Helios point cloud data

## D.5 View Offline Data

About how to parse data offline (rosviz or pcap), there is also a detailed introduction in the documentation in the rslidar\_sdk driver package. Here is just a brief introduction, taking pcap as an example. You can use rslidar\_sdk to parse the saved offline pcap file into point cloud data for display.

1. Modify the parameters in rslidar\_sdk/config/config.yaml

msg\_source: modified to 3

pcap\_directory: configure to the absolute path of the pcap file:

(e.g. /home/robosense/RSHelios.pcap)

2. Open the terminal and run the node program:

```
cd ~/catkin_ws
source devel/setup.bash
roslaunch rslidar_sdk start.launch
```



Appendix E Mechanical Drawings

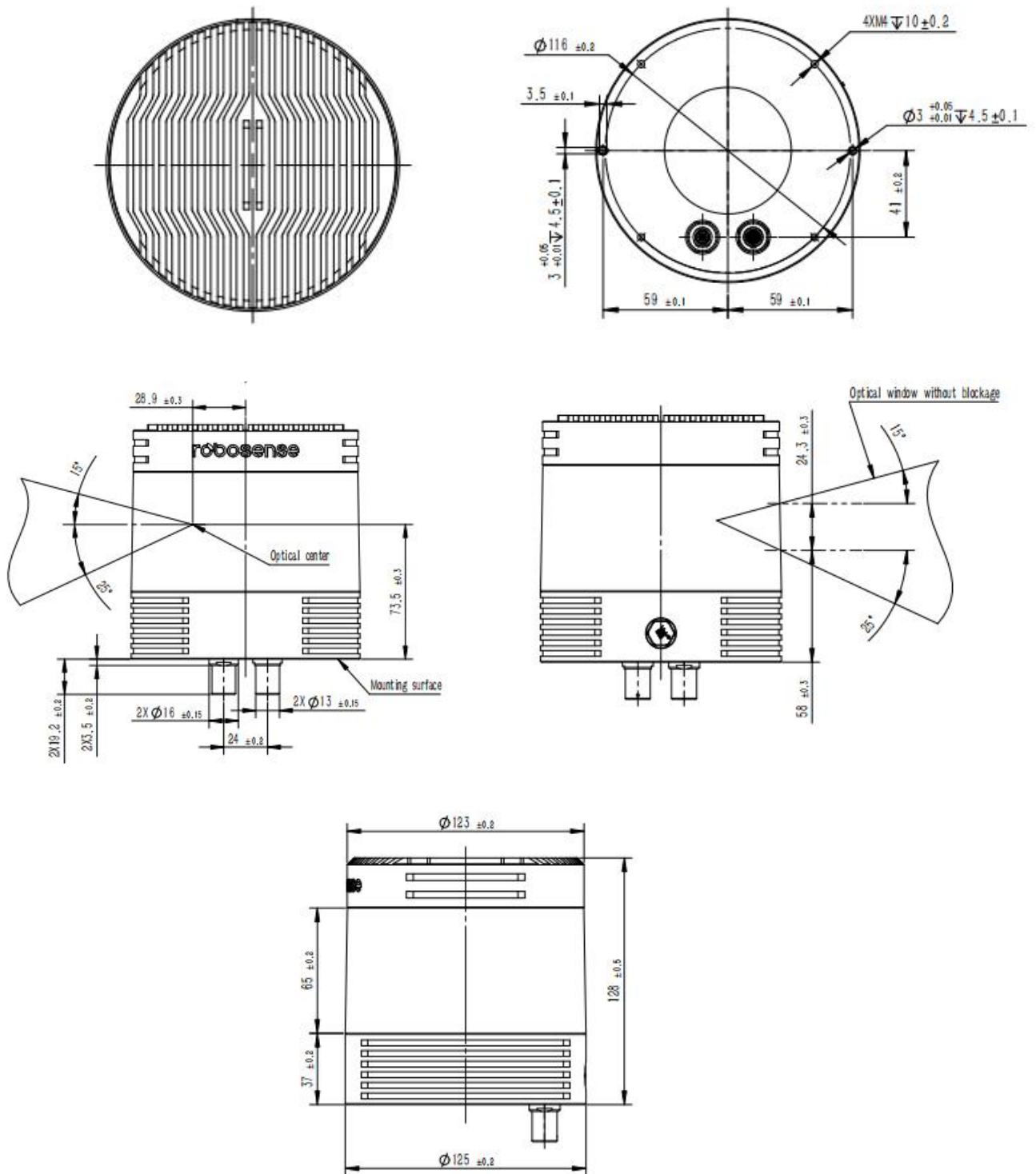

## Appendix F Correspondence Table of Channel Ranging Ability

| Channel Number | Vertical Angle | Horizontal Offset | Blind Spot | Ranging Ability @10%NIST | Darthest Distance | Proximity Channel | Remote Channel | Channel Number | Vertical Angle | Horizontal Offset | Blind Spot | Ranging Ability @10%NIST | Darthest Distance | Proximity Channel | Remote Channel |
|----------------|----------------|-------------------|------------|--------------------------|-------------------|-------------------|----------------|----------------|----------------|-------------------|------------|--------------------------|-------------------|-------------------|----------------|
| 1              | -11.78         | 5.94              | 0.4m       | 50m                      | 80m               | Y                 | -              | 65             | -0.89          | 5.94              | 1m         | 240m                     | 240m              | -                 | Y              |
| 2              | -10.37         | 2.39              | 3m         | 50m                      | 80m               | -                 | -              | 66             | -0.79          | 2.39              | 3m         | 240m                     | 240m              | -                 | Y              |
| 3              | -9.27          | -1.15             | 1m         | 50m                      | 80m               | -                 | -              | 67             | -0.69          | -1.15             | 1m         | 240m                     | 240m              | -                 | Y              |
| 4              | -8.38          | -4.69             | 1m         | 50m                      | 80m               | -                 | -              | 68             | -0.59          | -4.69             | 3m         | 240m                     | 240m              | -                 | Y              |
| 5              | -16.07         | 4.70              | 0.4m       | 50m                      | 80m               | Y                 | -              | 69             | -1.29          | 4.72              | 1m         | 240m                     | 240m              | -                 | Y              |
| 6              | -25.1          | 1.17              | 0.4m       | 50m                      | 80m               | Y                 | -              | 70             | -1.19          | 1.18              | 3m         | 240m                     | 240m              | -                 | Y              |
| 7              | -19.64         | -2.38             | 0.4m       | 80m                      | 80m               | Y                 | -              | 71             | -1.09          | -2.36             | 1m         | 240m                     | 240m              | -                 | Y              |
| 8              | -13.61         | -5.92             | 0.4m       | 80m                      | 80m               | Y                 | -              | 72             | -0.99          | -5.90             | 3m         | 240m                     | 240m              | -                 | Y              |
| 9              | -6.52          | 5.94              | 0.4m       | 80m                      | 80m               | Y                 | -              | 73             | -0.09          | 5.94              | 1m         | 240m                     | 240m              | -                 | Y              |
| 10             | -6.4           | 2.39              | 3m         | 80m                      | 80m               | -                 | -              | 74             | 0.01           | 2.39              | 3m         | 240m                     | 240m              | -                 | Y              |
| 11             | -6.31          | -1.15             | 0.4m       | 80m                      | 80m               | Y                 | -              | 75             | 0.11           | -1.15             | 1m         | 240m                     | 240m              | -                 | Y              |
| 12             | -6.21          | -4.69             | 3m         | 80m                      | 80m               | -                 | -              | 76             | 0.21           | -4.69             | 3m         | 240m                     | 240m              | -                 | Y              |
| 13             | -7.67          | 4.72              | 0.4m       | 80m                      | 80m               | Y                 | -              | 77             | -0.49          | 4.72              | 1m         | 240m                     | 240m              | -                 | Y              |
| 14             | -7.17          | 1.18              | 3m         | 80m                      | 80m               | -                 | -              | 78             | -0.39          | 1.18              | 3m         | 240m                     | 240m              | -                 | Y              |
| 15             | -6.87          | -2.36             | 0.4m       | 80m                      | 80m               | Y                 | -              | 79             | -0.29          | -2.36             | 1m         | 240m                     | 240m              | -                 | Y              |
| 16             | -6.67          | -5.91             | 1m         | 80m                      | 80m               | -                 | -              | 80             | -0.19          | -5.90             | 3m         | 240m                     | 240m              | -                 | Y              |
| 17             | -5.71          | 5.94              | 1m         | 80m                      | 80m               | -                 | -              | 81             | 0.71           | 5.94              | 1m         | 240m                     | 240m              | -                 | Y              |
| 18             | -5.6           | 2.39              | 3m         | 80m                      | 80m               | -                 | -              | 82             | 0.81           | 2.39              | 3m         | 240m                     | 240m              | -                 | Y              |
| 19             | -5.51          | -1.15             | 0.4m       | 80m                      | 80m               | Y                 | -              | 83             | 0.91           | -1.15             | 0.4m       | 240m                     | 240m              | Y                 | Y              |
| 20             | -5.41          | -4.69             | 3m         | 80m                      | 80m               | -                 | -              | 84             | 1.01           | -4.69             | 3m         | 240m                     | 240m              | -                 | Y              |
| 21             | -6.1           | 4.72              | 1m         | 80m                      | 80m               | -                 | -              | 85             | 0.31           | 4.72              | 1m         | 240m                     | 240m              | -                 | Y              |
| 22             | -6.01          | 1.18              | 3m         | 80m                      | 80m               | -                 | -              | 86             | 0.41           | 1.18              | 3m         | 240m                     | 240m              | -                 | Y              |
| 23             | -5.91          | -2.36             | 0.4m       | 80m                      | 80m               | Y                 | -              | 87             | 0.51           | -2.36             | 1m         | 240m                     | 240m              | -                 | Y              |
| 24             | -5.81          | -5.91             | 3m         | 80m                      | 80m               | -                 | -              | 88             | 0.61           | -5.90             | 3m         | 240m                     | 240m              | -                 | Y              |
| 25             | -4.9           | 5.94              | 1m         | 80m                      | 80m               | -                 | -              | 89             | 1.51           | 5.94              | 1m         | 150m                     | 200m              | -                 | -              |
| 26             | -4.8           | 2.39              | 3m         | 80m                      | 80m               | -                 | -              | 90             | 1.61           | 2.39              | 3m         | 150m                     | 200m              | -                 | -              |
| 27             | -4.7           | -1.15             | 0.4m       | 80m                      | 80m               | Y                 | -              | 91             | 1.71           | -1.15             | 1m         | 150m                     | 200m              | -                 | -              |
| 28             | -4.6           | -4.69             | 3m         | 80m                      | 80m               | -                 | -              | 92             | 1.82           | -4.69             | 3m         | 150m                     | 200m              | -                 | -              |
| 29             | -5.3           | 4.72              | 1m         | 80m                      | 80m               | -                 | -              | 93             | 1.11           | 4.72              | 1m         | 150m                     | 200m              | -                 | -              |
| 30             | -5.2           | 1.18              | 3m         | 80m                      | 80m               | -                 | -              | 94             | 1.21           | 1.18              | 3m         | 150m                     | 200m              | -                 | -              |
| 31             | -5.1           | -2.36             | 1m         | 80m                      | 80m               | -                 | -              | 95             | 1.31           | -2.36             | 0.4m       | 150m                     | 200m              | Y                 | -              |
| 32             | -5             | -5.91             | 3m         | 80m                      | 80m               | -                 | -              | 96             | 1.41           | -5.90             | 3m         | 150m                     | 200m              | -                 | -              |
| 33             | -4.1           | 5.94              | 1m         | 135m                     | 135m              | -                 | -              | 97             | 2.32           | 5.94              | 1m         | 135m                     | 135m              | -                 | -              |
| 34             | -4             | 2.39              | 3m         | 135m                     | 135m              | -                 | -              | 98             | 2.41           | 2.39              | 3m         | 135m                     | 135m              | -                 | -              |
| 35             | -3.9           | -1.15             | 0.4m       | 135m                     | 135m              | Y                 | -              | 99             | 2.52           | -1.15             | 1m         | 135m                     | 135m              | -                 | -              |
| 36             | -3.8           | -4.69             | 3m         | 135m                     | 135m              | -                 | -              | 100            | 2.62           | -4.69             | 3m         | 135m                     | 135m              | -                 | -              |
| 37             | -4.5           | 4.72              | 1m         | 135m                     | 135m              | -                 | -              | 101            | 1.91           | 4.72              | 1m         | 135m                     | 135m              | -                 | -              |
| 38             | -4.4           | 1.18              | 3m         | 135m                     | 135m              | -                 | -              | 102            | 2.02           | 1.18              | 3m         | 135m                     | 135m              | -                 | -              |
| 39             | -4.3           | -2.36             | 0.4m       | 135m                     | 135m              | Y                 | -              | 103            | 2.12           | -2.36             | 1m         | 135m                     | 135m              | -                 | -              |
| 40             | -4.2           | -5.91             | 3m         | 135m                     | 135m              | -                 | -              | 104            | 2.22           | -5.90             | 3m         | 135m                     | 135m              | -                 | -              |
| 41             | -3.3           | 5.94              | 1m         | 150m                     | 200m              | -                 | -              | 105            | 3.12           | 5.94              | 1m         | 135m                     | 135m              | -                 | -              |
| 42             | -3.2           | 2.39              | 3m         | 150m                     | 200m              | -                 | -              | 106            | 3.22           | 2.39              | 3m         | 135m                     | 135m              | -                 | -              |
| 43             | -3.1           | -1.15             | 0.4m       | 150m                     | 200m              | Y                 | -              | 107            | 3.32           | -1.15             | 1m         | 135m                     | 135m              | -                 | -              |
| 44             | -3             | -4.69             | 3m         | 150m                     | 200m              | -                 | -              | 108            | 3.42           | -4.69             | 3m         | 135m                     | 135m              | -                 | -              |
| 45             | -3.7           | 4.72              | 1m         | 150m                     | 200m              | -                 | -              | 109            | 2.72           | 4.72              | 1m         | 135m                     | 135m              | -                 | -              |
| 46             | -3.6           | 1.18              | 3m         | 150m                     | 200m              | -                 | -              | 110            | 2.82           | 1.18              | 3m         | 135m                     | 135m              | -                 | -              |
| 47             | -3.5           | -2.36             | 0.4m       | 200m                     | 200m              | Y                 | -              | 111            | 2.92           | -2.36             | 0.4m       | 135m                     | 135m              | Y                 | -              |
| 48             | -3.4           | -5.90             | 3m         | 200m                     | 200m              | -                 | -              | 112            | 3.02           | -5.90             | 3m         | 135m                     | 135m              | -                 | -              |
| 49             | -2.5           | 5.94              | 1m         | 200m                     | 200m              | -                 | -              | 113            | 3.97           | 5.94              | 0.4m       | 135m                     | 135m              | Y                 | -              |
| 50             | -2.39          | 2.39              | 3m         | 200m                     | 200m              | -                 | -              | 114            | 4.17           | 2.39              | 3m         | 135m                     | 135m              | -                 | -              |
| 51             | -2.3           | -1.15             | 0.4m       | 200m                     | 200m              | Y                 | -              | 115            | 4.42           | -1.15             | 1m         | 135m                     | 135m              | -                 | -              |
| 52             | -2.2           | -4.69             | 3m         | 200m                     | 200m              | -                 | -              | 116            | 4.72           | -4.69             | 3m         | 135m                     | 135m              | -                 | -              |
| 53             | -2.9           | 4.72              | 1m         | 200m                     | 200m              | -                 | -              | 117            | 3.52           | 4.72              | 1m         | 135m                     | 135m              | -                 | -              |
| 54             | -2.8           | 1.18              | 3m         | 200m                     | 200m              | -                 | -              | 118            | 3.62           | 1.18              | 3m         | 135m                     | 135m              | -                 | -              |
| 55             | -2.7           | -2.36             | 1m         | 200m                     | 200m              | -                 | -              | 119            | 3.72           | -2.36             | 0.4m       | 135m                     | 135m              | Y                 | -              |
| 56             | -2.6           | -5.90             | 3m         | 200m                     | 200m              | -                 | -              | 120            | 3.82           | -5.91             | 3m         | 135m                     | 135m              | -                 | -              |
| 57             | -1.69          | 5.94              | 1m         | 240m                     | 240m              | -                 | Y              | 121            | 7.43           | 5.94              | 1m         | 135m                     | 135m              | -                 | -              |
| 58             | -1.59          | 2.39              | 3m         | 240m                     | 240m              | -                 | Y              | 122            | 9.02           | 2.39              | 3m         | 135m                     | 135m              | -                 | -              |
| 59             | -1.49          | -1.15             | 0.4m       | 240m                     | 240m              | Y                 | Y              | 123            | 11.53          | -1.15             | 0.4m       | 135m                     | 135m              | Y                 | -              |
| 60             | -1.39          | -4.69             | 3m         | 240m                     | 240m              | -                 | Y              | 124            | 15.04          | -4.70             | 0.4m       | 135m                     | 135m              | Y                 | -              |
| 61             | -2.09          | 4.72              | 1m         | 240m                     | 240m              | -                 | Y              | 125            | 5.07           | 4.72              | 0.4m       | 135m                     | 135m              | Y                 | -              |
| 62             | -2             | 1.18              | 3m         | 240m                     | 240m              | -                 | Y              | 126            | 5.48           | 1.18              | 3m         | 135m                     | 135m              | -                 | -              |
| 63             | -1.9           | -2.36             | 1m         | 240m                     | 240m              | -                 | Y              | 127            | 5.98           | -2.36             | 0.4m       | 135m                     | 135m              | Y                 | -              |
| 64             | -1.8           | -5.90             | 3m         | 240m                     | 240m              | -                 | Y              | 128            | 6.58           | -5.91             | 1m         | 135m                     | 135m              | -                 | -              |

## Appendix G Sensor Cleaning

In order to be able to accurately sense the surrounding environment, LiDAR needs to be kept clean, especially the optical ring lens.

### G.1 Attention

Please read the contents of this appendix F carefully and completely before cleaning your LiDAR, otherwise improper operation may damage the sensor. When the LiDAR is used in a harsh environment, it is necessary to clean up the dirt on the surface in time to keep the LiDAR clean, otherwise it will affect the normal use of the LiDAR

### G.2 Cleaning Method

1. Clean fiber cloth
2. Spray with neutral warm soap
3. Spray with clean water
4. Isopropanol solvent
5. Clean gloves

### G.3 Required Materials

If there is only some dust adhered to the surface of the sensor, you can directly dip a small amount of isopropanol solution with a clean fiber cloth, and then gently wipe the LiDAR surface to clean, and then wipe it dry with a clean fiber cloth.

If the surface of the LiDAR is caked with mud or dirt, first spray clean water on the surface of the dirty part to remove the mud or the dirt (Note: Do not try to wipe off the mud directly with a fiber cloth, as this may scratch the surface, especially the optical ring lens.). Secondly, spray warm soapy water on the dirty parts (The lubricating effect of soapy water can accelerate the detachment of the dirt). Gently wipe the surface of the sensor with the fiber cloth again, be careful not to scratch the surface. Finally, clean the soap residue on the surface with clean water (If there are still residues on the surface, use an isopropyl alcohol solution to clean it again), and wipe it dry with a clean microfiber cloth



robosense

[www.robosense.ai](http://www.robosense.ai)

Suteng Innovation Technology Co., Ltd.

RoboSense Global Headquarters - Building 9, Block 2, Zhongguan Honghualing Industry Southern District,  
1213 Liuxian Avenue, Taoyuan Street, Nanshan District, Shenzhen, China



RoboSense LIDAR